

Application Diagram

Application diagram 1 - Multiple Sensor Modules

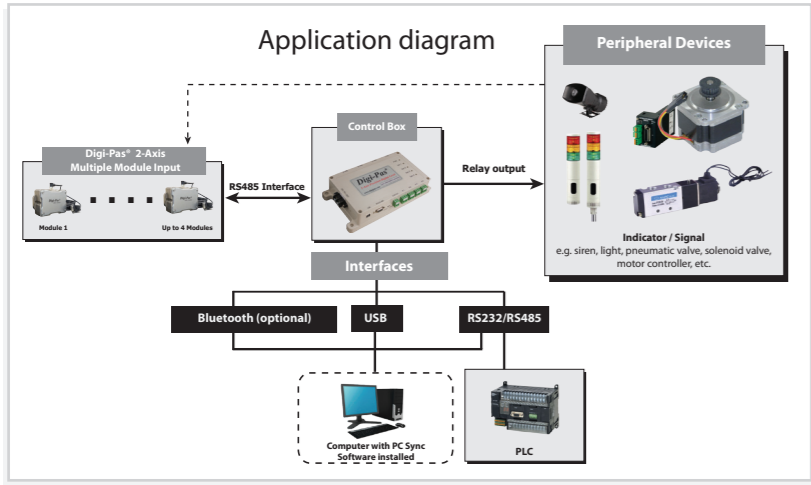

Software Features Comparison

Features	Pc Sync Free Edition	Pc Sync Pro Edition
Relay Contact Output		✓
SMART 2D BUBBLE®		✓
Single-Axis Angle Meter	✓	✓
Single-Axis Angle Graph	✓	✓
Dual-Axis Angle Graph		✓
Vibrometer Graph		✓

2-Axis Inclination Sensor Module

Model : DWL-5000XY, DWL-5500XY & DWL-5800XY

RS232 RS485 Bluetooth USB



Application diagram 2 - Single Sensor Module

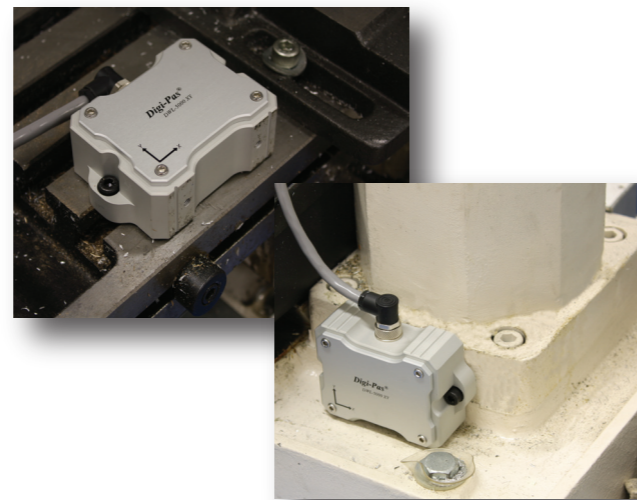
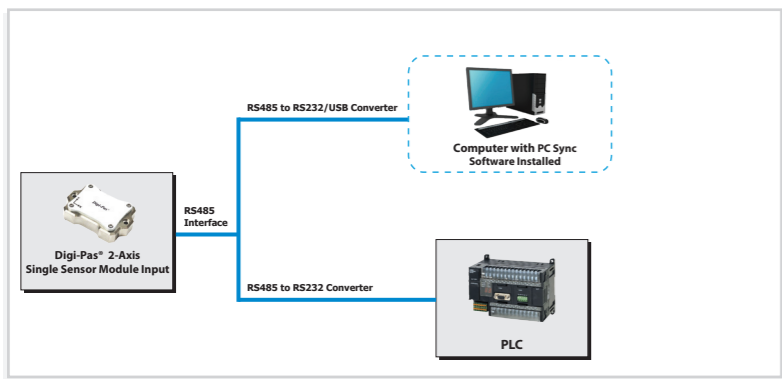

Accuracy

± 0.01° (175µm/M)

± 0.001° (18µm/M)

1 arcsec. (≤ 5µm/M)

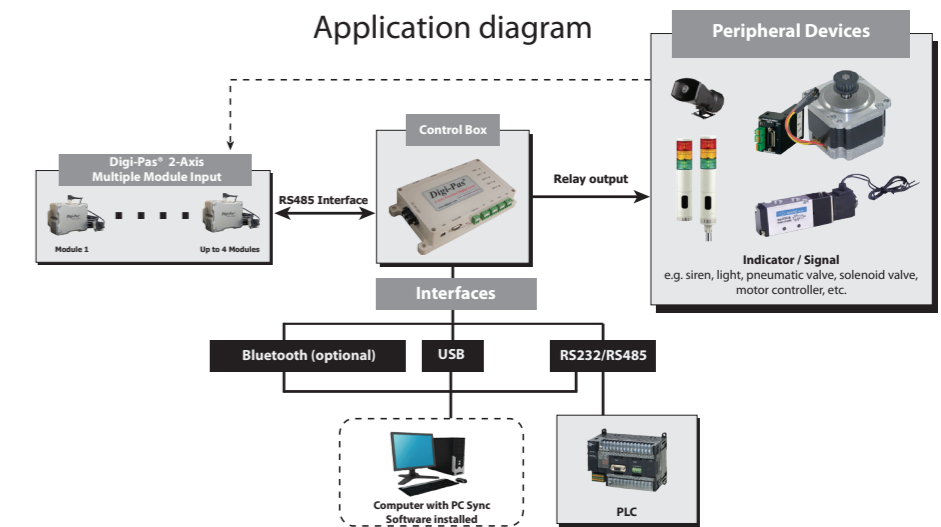

PC System Requirements

User's PC is recommended the following items to be installed for using the PC Sync Software:

- Microsoft framework 3.5 for 32bit Windows OS or Microsoft framework 4.0 for 64bit Windows OS
- Windows XP service pack 3 / Windows Vista / Windows 7 / Window 10

The following item are required:

- At least 1 GB RAM, at least 100MB free disk space on hard drive, Microsoft Excel 2007 or above, USB 2.0 Port or RS232 Port, Bluetooth adapter (for Bluetooth connection)

Applications :

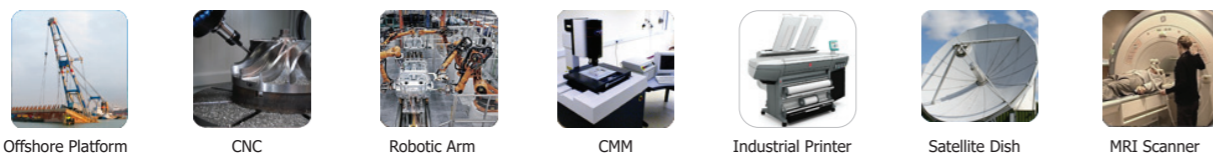

Authorised Distributor:

DIGIPAS TECHNOLOGIES INC.
www.digipas.com
200 Spectrum Center Drive, Suite 300,
Irvine, CA 92618 U.S.A



JCL-2-039999-99-006

Digi-Pas® DWL-5000XY, DWL-5500XY & DWL-5800XY are 2-Axis Inclination Sensor Modules that specifically designed to be integrated into machine/equipment/structure with capability of real-time simultaneous monitoring of plane levelling position, 2D tilt angles, vibration measurement and data logging function when used with the 'Plug and Play' PC Sync Software. These intelligent modules are embedded with advanced MEMS sensor technology, developed for application engineers to ensure precision structural stability or angular position on any desired object.

These smart inclination sensor modules are tough, durable, IP65 waterproof, shock resistance, small footprint and enabled to communicate with external peripheral devices through various protocols such as **USB, RS232, RS485, & wireless Bluetooth.**

Innovation & Technology Driven™

© 2021 Digipas Technologies Inc. All Rights Reserved.

Products tested by TÜV SÜD, SGS accredited body to comply with CE, FCC & RoHS, calibrated traceable to UKAS, JIS, NIST & DIN, and manufactured under SGS certified ISO quality standards:



Manufacturer Representatives/
Distributors:

Digi-Pas® USA (Americas)
Digipas Technologies Inc.
info@digipas.com

Digi-Pas® 迪派士™ China
Ipiranga (Shanghai) Transmission Technology Co., Ltd.
info@digipaschina.com

Digi-Pas® South Korea
Phenix Trading Co., Ltd.
info@digipas.com

Digi-Pas® Europe
Dutch Instruments
info@digipas.de

Digi-Pas® Japan
JSB Tech Japan Co., Ltd.
info@digipas.co.jp

Digi-Pas® Singapore
JSB Tech Pte Ltd
info@digipas.com

2-Axis Inclination Sensor Module

Professional PC Sync Software

The PC Sync Software is a 'plug & play' interface software (embedded with National Instrument software) that enables application engineers to remote access to multiple tilt sensor modules instantly via wireless Bluetooth connectivity/ USB cable/ RS232 for plane levelling, 2D tilt angles and vibration measurement. With the remote real-time data acquisition, logging & analysis features, the software offers a comprehensive solution without the need for tedious and time-consuming programming.

Technical Specification

Model	DWL-5000XY	DWL-5500XY	DWL-5800XY
Measurement Range (Single Axis Mode)	0.00° to ± 90.00°	0.000° to ± 10.000°	0 ~ ±14400 arcsec.
Measurement Range (Dual Axis Mode)	0.00° to ± 15.00°	0.000° to ± 5.000°	0 ~ ±3600 arcsec.
Resolution	0.01° (175 µm/M or 0.002 in/ft)	0.001° (18 µm/M or 0.0002 in/ft)	1 arcsec; (≤5 µm/M)
Accuracy	± 0.01° at 0° to 2.00° ± 0.03° at other angles	± 0.001° at 0° to 2.000° ± 0.003° at other angles	± 1 arcsec. at 0 to ±1080 arcsec. ± 3 arcsec. at other angles
Repeatability	± 0.01° (175 µm/M or 0.002 in/ft)	± 0.001° (18 µm/M or 0.0002 in/ft)	1 arcsec; (≤5 µm/M)
Cross Axis Error	Negligible (± 0.0025°)	Negligible (± 0.00025°)	Negligible (± 0.0001°)
Vibrometer (Relative g)	1.0	2.0	2.0
Response time	10ms (milliseconds)	500ms (milliseconds)	500ms (milliseconds)
Power Supply	9V DC		
IO communication protocols	RS232/ RS485: 8 Data bits, no parity, 1 stop bits, 115200bps USB 2.0 or Wireless Bluetooth connectivity (optional)		
Sensor Module Waterproof Rating	IP65		
Sensor Module Base Material	Aluminium	Steel / Aluminium	Steel / Aluminium
Sensor Module Dimension (mm)	90 x 60 x 33		120 x 80 x 43
Sensor Module Weight (approx.)	400g	600g	1200g
Operating Temperature	-20°C to +70°C		10°C to +40°C
Storage Temperature	-30°C to +80°C		-30°C to +80°C

Note : Product Specification and appearance are subjected to change for product improvement without prior notice.

Control Box Overview

- Programmable Relay Contacts Outputs: Enables user-defined tilt angle/vibration range limits settings to trigger peripheral devices (e.g. siren/alarm, valve, motor, strobe lights, etc.)
- Multiple I/O communication protocols i.e. USB, RS232, RS485 & Wireless Bluetooth connectivity (optional)



Control Box

PC Sync Software Features

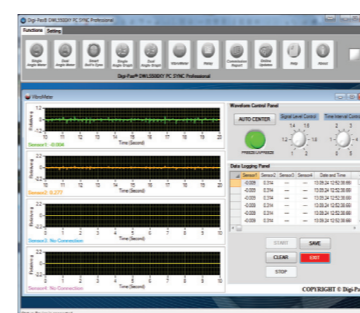
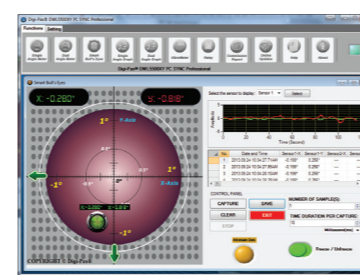

Relay Contact Output

- Enables user to define pre-set condition to activate any connected peripheral devices e.g. siren/alarm, valve, motor, strobe lights, etc.
- User-defined settings, real-time feedback of relay output status and tilt sensor module measurement readings can be seen at a glance on PC screen

SMART 2D BUBBLE®

- View and record real-time 2-axis angles readings from a selected tilt sensor module
- Simultaneous display of graphical bull's eye (with auto range feature) and numeric formats
- Plane surface's elevation point clearly indicated by Smart 2D Bubble®

Single-Axis & Dual-Axis Angle Graphs

- Distinctive line graph display and numerical readings of angle/levelling measurement from multiple tilt sensor modules
- Enables identification and comparison of real-time results among multiple connected tilt sensor modules
- Enables data saving in Excel format

VibroMeter Graph

- Numeric and graphical display of vibration magnitude and pattern/graph for effective vibration conditions assessment
- Simultaneous display of Vibrographs for multiple operating tilt sensor modules
- Fast sampling rate at 10ms (milliseconds) per data capture

Single-Axis Angle Meters

- Graphical and numerical display for real-time single-axis readings of multiple tilt sensor modules
- Large, easy-to-read display with units in degree(°), mm/M or In/Ft

ACCREDITATION

DWL-5000XY Series Tilt Sensor Modules accuracy is verified by accredited 3rd party independent calibration & test bodies and National Metrology Centre traceable to SI standard and NIST, JIS, UKAS & DIN under CIPM MRA.

Advantages of Digi-Pas® 2-Axis Inclination Sensor Module

- PLANAR & WIDE ANGLE RANGE MEASUREMENT
Precision levelling and tilt angles measurement essentially involve simultaneous 2-dimensional planes rather than single-axis. Digi-Pas® 2-axis intelligent tilt sensor modules having high precision and wide measurement range are capable of providing real-time levelling & vibration readings that empower application engineers to continuously monitor machine/equipment/structure angular positional status precisely and speedily.

These small footprint MEMS driven 2-axis sensor modules effectively eliminate the limitations of using multiple single-axis sensors or bulky pendulum based sensors to achieve 2D levelling and planar angular measurements.

- PROGRAMMABLE & USER-DEFINABLE SYSTEM
Digi-Pas® 2-axis tilt sensor module system is designed to be integrated into precision machine/equipment/structure enabling application engineers to instantly access angular positional status without the need for tedious and time-consuming programming.

The angular measurement system enables user-defined settings to activate any external connected peripheral devices at ease.

Sensor Module Dimension

DWL-5800XY Sensor Dimension

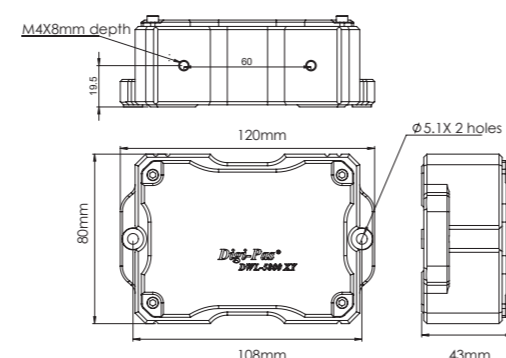

DWL-5000XY & DWL 5500XY Sensor Dimension

