

DVP01PU-S

Positioning Unit Instruction Sheet

1 WARNING

- ⚠ This Instruction Sheet only provides descriptions for installation, wiring and trial run. For further information, please refer to special module of PLC Application Manual.
- ⚠ Do NOT touch terminals when power on. Please must power OFF before wiring.
- ⚠ This is an OPEN TYPE PLC. The PLC should be kept in an enclosure away from airborne dust, humidity, electric shock risk and vibration. Also, it is equipped with protective methods such as some special tools or keys to open the enclosure in order to prevent hazard to users or damage the PLC.
- ⚠ Do NOT connect the AC input power to any of the input/output terminals, or it may damage the PLC. Check all the wiring prior to power up.

2 INTRODUCTION

2.1 Model Description and Peripherals

01PU (positioning unit) is mainly applied to the speed/position control of step/servo driven system. The maximum output pulse can be up to 200 KPPS, and built-in various route control modes. The DVP-PLC SS/SA/SX/SC series can read/write 01PU via FROM/TO instructions. There are 49 CRs (Control Register) with 16-bit for each register in 01PU. The 32-bits data is composed of 2 continuous CR number.

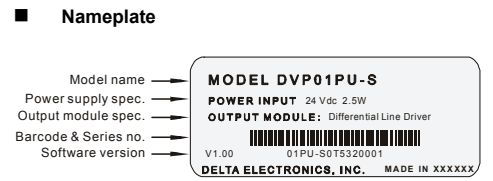

Model & Serial Number

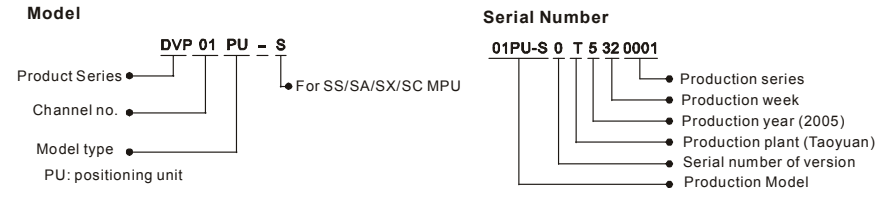

2.2 Product Profile and Outline (LED Indicator and Terminal Block)

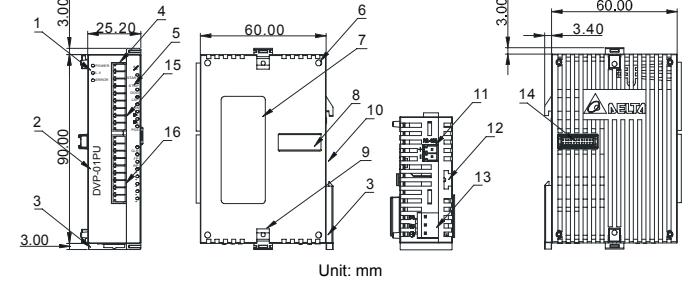

1. Status Indicator (Power, L.V. and ERROR)	2. Model name	Upper Row	Lower Row
3. DIN rail clip	4. Terminal	S/S	A-
5. Terminal indicator	6. Mounting hole	START	B+
7. Nameplate	8. Extension port to connect extension module	STOP	B-
9. Extension unit/module clip	10. DIN rail track (35mm)	DOG	CLR+
11. RS-485 communication port	12. Clip for combining extension modules	LSP	CLR-
13. Power input	14. Extension port to connect extension module	LSN	FP+
15. Upper row terminals	16. Lower row terminals	PG0+	FP-
		PG0-	RP+
		A+	RP-

LED Display

POWER : Power indicator, +5V internal power	START : Start input
LV : Low voltage indicator lit when external input power is lower than 19.5V	STOP : Stop input
ERROR : Error indicator (ON/OFF blinking). It will blink when CR#39 is not 0.	DOG : DOG (near point signal) input
LSP : Right limit input indicator	FP : CW pulse output
LSN : Left limit input indicator	RP : CCW pulse output
PG0 : Zero signal input indicator	ΦA : A-phase input of manual pulse generator
	ΦB : B-phase input of manual pulse generator
	CLR : Output clear signal

Input/Output Terminal

Description	Terminal name	Content	Response
Power supply	+24V, 0V	Power input/DC24V (-15~+20%) Current consumption 70±10mA; Startup peak current 1.3 A	-

Description	Terminal name	Content	Response
Input	START	Start input terminal	4ms/12ms
	STOP	Stop input terminal	4ms
	LSP / LSN	Limit Stroke of right/left limit	1ms
	ΦA+, ΦA-	A-phase terminal (+, -) of manual pulse generator input (line driver input)	200KHz
	ΦB+, ΦB-	B-phase terminal (+, -) of manual pulse generator input (line driver input)	200KHz
	PG0+, PG0-	Zero signal input terminal +, - (line driver input)	4ms
Output	DOG	Offers two different functions depending on operation mode. (1) It is near-point signal in zero return mode. (2) It is start signal on interrupt 1st or interrupt 2nd speed mode.	1ms
	S/S	Signal common terminal of these Inputs (START, STOP, DOG, LSP, LSN)	-
	CLR+, CLR-	Clear signal (clear signal of internal error counter for Servo drive)	4ms
	FP+, FP-	FP/RP mode: CW pulse output I/O mode: Output pulse AB-phase mode: A-phase output	200KHz
	RP+, RP-	FP/RP mode: CCW pulse output I/O mode: direction output AB-phase mode: B-phase output	200KHz

Input/Output Circuit

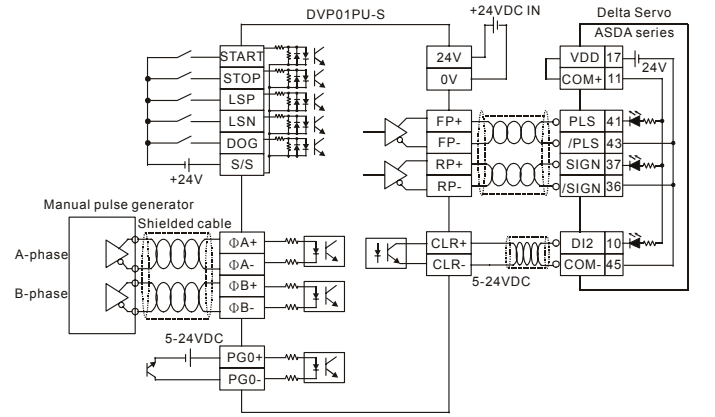

- Note:
- Please use 22-16AWG (1.5mm) wiring (either single or multiple core) for I/O wiring terminals. PLC terminal screws should be tightened to 1.95 kg-cm (1.7 in-lbs). Use copper conductors only, 60/75°C.
 - Do NOT arrange the wiring of I/O signal wires or power supply in the same wiring duct.
 - Make sure the terminals Ⓢ of power module and DVP01PU-S are properly grounded or
 - Do NOT wire to null terminal ●.

3 SPECIFICATIONS

3.1 Function Specifications

Item	Content
Power supply	DC24V(-15% ~ +20%) Current consumption 70±10mA; Startup peak current 1.3 A
Max. number of connected axes	8 units; (SS/SA/SX/SC series MPU can connect up to 8 extension modules without occupying any I/O.)
Distance instruction	Distance value is set by CR. 1. Setting range: -2, 147,483,648~+2,147,483,647 ; 2. Selectable unit: um, mdeg, 10 ⁻⁴ inch, Pulse ; 3. Selectable rate: 10 ⁰ , 10 ¹ , 10 ² , 10 ³ ; : 4. Selectable position: absolute and relative position instruction
Speed instruction	Speed value is set by CR. 1. Setting range: -2,147,483,648~+2,147,483,647 (conversion value of 10~200KPPS pulse) 2. Selectable unit: pulse/s, cm/min, 10deg/min, inch/min
External output	Photo coupler is for insulation and there are LED indications for all output/input signals. Outputs: FP and RP (line driver output 5V) Output: CLR is the type of NPN open collector transistor output (5~24VDC, less than 20mA)
External input	Photo coupler is for insulation and there are LED indications for all output/input signals. Input point: START, STOP, LSP, LSN, DOG(contact or open collector transistor, 24VDC±10%, 5±1mA) Inputs: ΦA, ΦB(line driver or open collector transistor, 5~24VDC, 6~15mA) Input: PG0 (line driver or open collector transistor, 5~24VDC, 6~15mA)
Pulse output format	Three selectable modes: Pulse/Dir, FP (CW)/RP (CCW), A/B (all modes are line driver output)
Position program & data transmission	CR data can be read/write via FROM/TO instruction of PLC MPU. The 32-bit data is composed of 2 continuous CR number. The range of 16-bit CR is CR#0 ~ CR#48.
Connect to DVP-PLC series	modules are numbered from 0~7 with 0 closet and 7 farthest to the MPU. Up to 8 modules can be connected without occupying any digital I/O.

3.2 Other Specification

Environmental specifications	
Operation/Storage	1. Operation: 0°C~55°C (Temperature), 50~95%(Humidity), pollution degree 2 2. Storage: -25°C~70°C (Temperature), 5~95% (Humidity)
Vibration/Shock immunity	Standard: IEC1131-2, IEC 68-2-6 (TEST Fc)/ IEC1131-2 & IEC 68-2-27 (TEST Ea)
Approvals	

4 CR (Control Register)

DVP01PU-S Positioning Unit							
CR No.				Content		Setting Range	
HW	LW	Address	Attribute				
#0	H'4190	✓	R	Model No.	System setting, Read-only (The model number of DVP01PU-S is H'0110.)		

#2	#1	H'4191	✓	R/W	Pulse rate (A)	Range: 1 ~ +2,147,483,647 PPS/REV, factory setting: 2,000 Pulse/Revolution (PLS/REV)
#4	#3	H'4193	✓	R/W	Feed rate (B)	Range: 1 ~ +2,147,483,647 unit/REV, Factory setting: 1,000 (unit*1/REV)
#5	H'4195	✓	R/W	Parameter setting: H'0000	b15 b14 b13 b12 b11 b10 b9 b8 b7 b6 b5 b4 b3 b2 b1 b0	STOP input polarity START input polarity START response time Acceleration curve options DOG polarity DOG trigger time Pulse direction Zero return direction LSN input polarity LSP input polarity Pulse output format Position rate setting Unit setting

b1	b0	Unit	Motor unit	Combined unit	Machine unit	b3	b2	Position rate setting	b5	b4	Pulse output format
0	0	Motor	pulse	um		0	0	10 ⁰	0	0	FP + RP
0	1	Machine	pulse	m deg		0	1	10 ¹	0	1	Pulse + direction
1	0	Combined	pulse	10 ⁻⁴ inch		1	0	10 ²	1	0	A/B Phase pulse
1	1					1	1	10 ³	1	1	

bit #	Content
6	When b[6]=0: positive logic. LSP input signal is ON and LPS signal is given. When b[6]=1: negative logic. LSP input signal is OFF and LPS signal is given.
7	When b[7]=0: positive logic. LSN input signal is ON and LSN signal is given. When b[7]=1: negative logic. LSN input signal is OFF and LSN signal is given.
8	When b[8]=0: zero return is executed to the direction of CP's decreasing value. When b[8]=1, zero return is executed to the direction of CP's increasing value.
9	When CW running is executed, b[9]=0 is for increasing CP value, but [9]=1 for decreasing.
10	When b[10]=0: DOG rising-edge is triggered. When b[10]=1,DOG falling-edge is triggered. (available for Interrupt 1st and interrupt 2nd speed position modes)
11	When b[11]=0: positive logic. When DOG input signal is ON, DOG near point signal is given. When b[11]=1: negative logic. When DOG input signal is OFF, DOG near point signal is given.
12	When b[12]=0: trapezoid acceleration line is chosen. When b[12]=1, S acceleration line is chosen.
13	When b[13]=0: 4ms; when b[13]=1: 12ms(for noise filter).
14	When b[14]=0: positive logic. When START input signal is ON, START input. When b[14]=1: negative logic. When START input signal is OFF, START input.
15	When b[15]=0: positive logic. When STOP input signal is ON, STOP input. When b[15]=1: negative logic. When STOP input signal is OFF, STOP input.

#7	#6	H'4196	✓	R/W	Maximum speed V _{max}	Range: 0 ~ +2,147,483,647 unit*1 (10 ~ 200K PPS) *2 Factory setting: 200,000 unit*1
#9	#8	H'4198	✓	R/W	Bias speed V _{bias}	Range: 0 ~ +2,147,483,647 unit*1 (0 ~ 200K PPS pulse transfer value) *2 Factory setting: 0 unit*1
#11	#10	H'419A	✓	R/W	JOG speed V _{JOG}	Range: 0 ~ +2,147,483,647 unit*1 (10 ~ 200K PPS pulse transfer value) *2 Factory setting: 5,000 unit*1
#13	#12	H'419C	✓	R/W	Zero return speed V _{RT}	Range: 0 ~ +2,147,483,647 unit*1 (10 ~ 200K PPS pulse transfer value) *2 Factory setting: 50,000 unit*1
#15	#14	H'419E	✓	R/W	Zero return deceleration speed V _{CR}	Range: 0 ~ +2,147,483,647 unit*1 (10 ~ 200K PPS pulse transfer value) *2 Factory setting: 1,000 unit*1
#16	H'41A0	✓	R/W		The number of PG0 in zero return mode N	Range: 0~+32,767 PLS Factory setting: 0 PLS
#17	H'41A1	✓	R/W		The number of pulse in zero return mode P	Range: -32,768 ~+32,767 PLS Factory setting: 0 PLS
#18	H'41A2	✓	R/W		Zero return mode H Mode	b0: Zero return mode, b1: detect DOG falling-edge in zero return mode

bit #	Content
0	b[0]=0: normal mode, b[0]=1: override mode
1	b[1]=0: DOG falling-edge detecting is on in zero return mode. b[1]=1: DOG falling-edge detecting is off in zero return mode.

#20	#19	H'41A3	✓	R/W	Zero point setting (HP)	Range: 0 ~ ±999,999 unit*1; factory setting: 0 unit*1
#21	H'41A5	✓	R/W		Acceleration time T _{acc}	Range: 10 ~ +32,767 ms; factory setting: 100 ms
#22	H'41A6	✓	R/W		Deceleration time T _{dec}	Range: 10 ~ +32,767 ms; factory setting: 100 ms
#24	#23	H'41A7	×	R/W	Target position (I) P(I)	Range: -2,147,483,648 ~ +2,147,483,647 pulse transfer value) *2; factory setting: 0 unit*1
#26	#25	H'41A9	×	R/W	Running speed (I) V(I)	Range: -2,147,483,648 ~ +2,147,483,647 unit*1 (10 ~ 200K PPS pulse transfer value) *2; factory setting: 1,000 unit*1
#28	#27	H'41AB	×	R/W	Target position (II) P(II)	Range: -2,147,483,648 ~ +2,147,483,647 unit*1 (-2,147,483,648 ~ +2,147,483,647 pulse transfer value) *2; factory setting: 0 unit*1
#30	#29	H'41AD	×	R/W	Running speed (II) V(II)	Range: 0 ~ +2,147,483,647 unit*1 (10 ~ 200K PPS pulse transfer value) *2; factory setting: 2,000 unit*1
#31	H'41AF	×	R/W		Running instruction factory setting: H'0000	b15 b14 b13 b12 b11 b10 b9 b8 b7 b6 b5 b4 b3 b2 b1 b0 CLR output (On/Off) CLR signal output mode Current position = 0 Software START ABS/REL Coordinate Zero return start JOG- JOG+ CCW pulse STOP CW pulse STOP Software STOP Error reset

bit #	Content	Action
0	When b[0]=1, Error reset. Error indicator is off and FLAG in CR (CR#38.b[5]) is cleared to 0.	0→1
1	When b[1]=0→1, this is the same function as external input signal that forces to stop. When external signal that forces to stop is inputted or when b[1]=0→1, PU will decelerate to stop.	0→1
2	When b[2]=1, CW running is forbidden. If CW running instruction is given, error will come up.	1
3	When b[3]=1, CCW running is forbidden. If CCW running instruction is given, error will come up.	1

4	When b[4]=0→1, CW pulse is generated in JOG+ mode.	0→1
5	When b[5]=0→1, CCW pulse is generated in JOG- mode.	0→1
6	When b[6]=0→1, zero return is performed. Zero return execution will differ based on current position (CP). There are four situations as follows: Position (1): Start position (as the right picture below [1]) is at the right of zero point and DOG(near point signal), DOG=Off. Position (2): Start position (as the right picture below [2]) is at the right of zero point, DOG=On. Position (3): Start position (as the right picture below [3]) is at the left of zero point and DOG(near point signal), DOG=Off and LSN (hardware limit switch) signal=Off. Position (4): Start position (as the left picture below [4]) is at the left of zero point and DOG(near point signal), DOG=Off and LSN (hardware limit switch) signal=On.	0→1

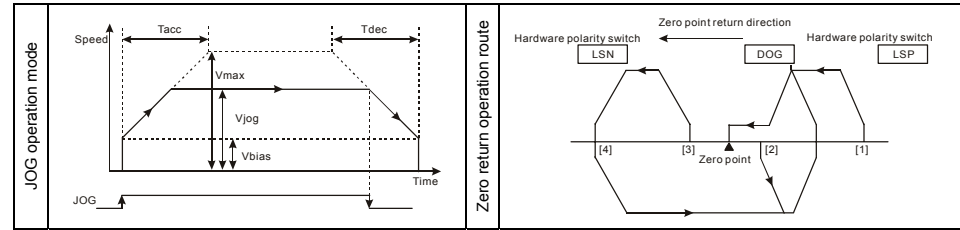

bit #	Content	Action
7	When b[7]=0, it is absolute position. When b[7]=1, it is relative position.	0/1
8	When b[8]=0→1, start running by the work mode of CR#32.	0→1
10	When b[10]=0→1, current position (CP) is cleared to 0.	0→1
12	When b[12]=0, CLR outputs 130ms to Servo when zero return is completed. It is the clear signal for servo internal error counter. When b[12]=1, CLR is common output point and the status(On/Off) is controlled by b[13].	0/1
13	When b[13]=0, CLR output is Off. When b[13]=1, CLR output is On.	0/1

bit #	Content	Action
#32	H'41B0 × R/W Work mode Factory setting: H'0001	

bit #	Content	Action
0	When b[0] is triggered and START ON, it starts to execute 1st-speed position program. Step number and speed are decided by P(I) & V(I).	
1	When b[1] is triggered, START ON, and DOG external near point signal is performed, it starts to reload the value of the target position (I) P(I) as relative position.	

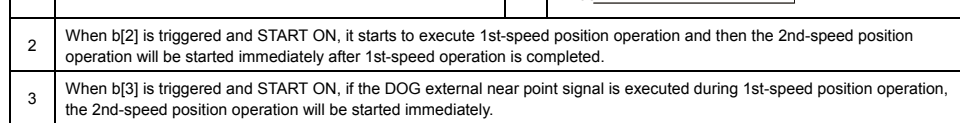

bit #	Content	Action
2	When b[2] is triggered and START ON, it starts to execute 1st-speed position operation and then the 2nd-speed position operation will be started immediately after 1st-speed operation is completed.	
3	When b[3] is triggered and START ON, if the DOG external near point signal is executed during 1st-speed position operation, the 2nd-speed position operation will be started immediately.	

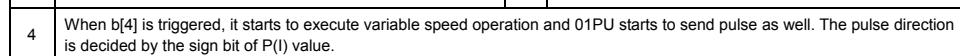

bit #	Content	Action
4	When b[4] is triggered, it starts to execute variable speed operation and 01PU starts to send pulse as well. The pulse direction is decided by the sign bit of P(I) value.	

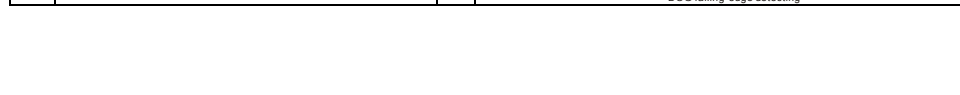

bit #	Content	Action
5	When b[5]=0→1, manual pulse generator input is started. Please refer to the setting of CR#40~#46.	
6	b[6]=0: When STOP is input, motor will decelerate to stop under running mode. When rerun instruction is received, motor will neglect the uncompleted distance and directly go executing the next position instruction. b[6]=1: When STOP is input, motor will decelerate to stop under running mode. When rerun instruction is received, motor will keep executing the uncompleted distance of previous instruction and then execute next position instruction.	
7	b[7]=0: The output pulse of manual pulse generator is unlimited. b[7]=1: The output pulse of manual pulse generator is limited between P(I) and P(II). When the output pulse is out of the range, it will decelerate and then stop outputting.	
8	b[8]=0: When motor is running, it will decelerate to stop if LSP/LSN signal is received. b[8]=1: When motor is running, it will stop immediately if LSP/LSN signal is received.	
9~11	MASK setting (1st-speed operation, 2nd-speed operation, interrupt 1st-speed operation, interrupt 2nd-speed operation) b[11~9]=K0(000) or other value: NO MASK function. b[11~9]=K1(001): the rising-edge of input terminal ΦA± will trigger MASK. b[11~9]=K2(010): the falling-edge of input terminal ΦA± will trigger MASK. b[11~9]=K3(011): the rising-edge of input terminal ΦB± will trigger MASK. b[11~9]=K4(100): the falling-edge of input terminal ΦB± will trigger MASK.	
12	b[12]=1: All parameters return to factory setting.	
13	b[13]=0: current position (CR34, 33) and current speed (CR36, 35). Display unit: pulse. b[13]=1: current position (CR34, 33) and current speed (CR36, 35). Display unit: unit.	

bit #	Content	Action
#34	#33 H'41B1 × R/W Current position CP (PLS) Range display: -2,147,483,648~+2,147,483,647 PLS Factory setting: 0 PLS	
#36	#35 H'41B3 × R/W Current speed CS (PPS) Range display: 0 ~ +2,147,483,647 PPS Factory setting: 0 PPS	
#37	H'41B5 × R/W Communication address and Baud rate setting RS-485 communication address setting: setting range 01~225; factory setting K1. Baud rate setting: 4800, 9600, 19200, 38400, 57600, and 115200 bps. ASCII mode data format is 7Bit, even bit and 1 stop bit (7 E 1). RTU mode data format is 8Bit, even bit and 1 stop bit (8 E, 1) b0: 4800 bps(bit/sec.), b1: 9600 bps(bit/sec.) (factory setting) b2: 19200 bps(bit/sec.), b3: 38400 bps(bit/sec.) b4: 57600 bps(bit/sec.), b5: 115200 bps(bit/sec.) b6: reserved, b7: 0 for RTU, 1 for ASCII mode, b8~b15: communication address	
#38	H'41B6 ✓ R/W Execution status factory setting: H'XXXX	

bit #	Content	Action
0	When b[0]=0, system is ready. When b[0]=1, 01PU is executing position control mode (Pulse is outputting).	
1	When b[1]=1, CW pulse is outputting.	
2	When b[2]=1, CCW pulse is outputting.	
3	When b[3]=1, zero return is completed and b[3] will be cleared by user-defined program. When 01PU is power on again, b[3] will be cleared to 0 automatically.	
4	When b[4]=1, "Current position CP(PLS)"(CR#34, #33) of 32 bit will overflow. When 01PU is power on again or complete zero return, b[4] will be cleared to 0 automatically.	
5	When b[5]=1, 01PU error occurred. Error code is stored in CR#39.	
6	When 01PU starts executing zero return or error reset (only when error occurred), it will clear b[6] to 0. When zero return or position control is completed, it will set b[6] to 1.	
7	When 01PU is running and STOP status is on, 01PU will stop output and b[7] will be set to 1. It means that 01PU is paused and it will execute the uncompleted route and b[7] will be cleared to 0 after STOP status is off.	
9	When b[9]=1, it means manual pulse generator inputs with counting upward.	
10	When b[10]=1, it means manual pulse generator inputs with counting downward.	

bit #	Content	Action
#39	H'41B7 × R Error code Please refer to "Error Code & Troubleshooting" for detail. Factory setting: H'0000	
#40	H'41B8 × R/W Electronic gearing numerator of MPG input Please refer to the following explanation Factory setting: H'1	
#41	H'41B9 × R/W Electronic gearing denominator of MPG input Please refer to the following explanation Factory setting: H'1	

- MPG (manual pulse generator) mode:
 - Manual pulse generator input mode is ON when b5 of CR#32 is set to 1.
 - 2-phase(A phase/B phase) can be input from the manual pulse generator to ΦA and ΦB. FP/PP I/O pulse is as follows:

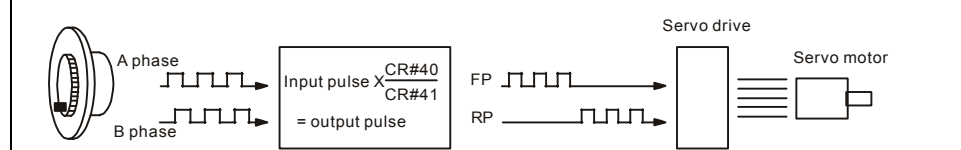

- When LSP/LSN is activated during running, output will stop immediately. When LSP is ON, CCW is allowed. When LSN is ON, CW is allowed. Positioning completed flag should be ON in this mode.
- Positioning completed indication (CR#38, b6=Off). When positioning control is completed, CR#38_b6 will be ON.
- The output speed is proportional to pulse frequency of manual pulse generator and the electronic gearing (CR#40, CR#41).

bit #	Content	Action
#42	H'41BA × R/W Input frequency of manual pulse generator The input frequency of manual pulse generator Factory setting: 0	
#44	H'41BC × R/W Accumulated pulse input no. of manual pulse generator The count value of CW manual pulse input is "+" symbol, on the contrary, the CCW manual pulse input is "-" symbol. And the count value is nothing to do with the ratio setting of manual electronic gearing (CR#40, #41). Factory setting: 0.	

bit #	Content	Action
#46	H'41BE × R/W Response speed of manual pulse generator Value: ≥5 4ms (factory setting) 4 32ms 3 108ms 2 256ms 1 or 0 500ms	
#47	H'41BF × R Terminal status bit # Status Description b0 START input When START input is On, b0 is On. b1 STOP input When STOP input is On, b1 is On. b2 DOG input When DOG input is On, b2 is On. b3 PG0 input When PG0 input is On, b3 is On. b4 LSP input When LSP input is On, b4 is On. b5 LSN input When LSN input is On, b5 is On. b6 A phase input When A phase input is On, b6 is On. b7 B phase input When B phase input is On, b7 is On. b8 CLR output When CLR output is On, b8 is On.	
#48	H'41C0 ✓ R System version System version is in hexadecimal. e.g. software V1.00 is for H'0100.	

- *1: Unit setting varies based on b0 and b1 setting of CR#5.
- *2: Use max. pulse output if upper limit is exceeded. Use min. pulse output if lower limit is exceeded.
- CR#0~CR#48: user can use the corresponding addresses H4190~41C0 to read/write data via RS-485 communication.
 - Baud rate supportive: 4800, 9600, 38400, 57600, and 115200 bps.
 - Modbus ASCII/RTU: ASCII mode is 7Bit, even bit and 1 stop bit (7 E 1). RTU mode is 8Bit, even bit and 1 stop bit (8 E, 1).
 - Function code: 03H for read data from CR; 06H for write one WORD in CR; 10H for write many WORDs in CR.

5 Used CR Corresponding to Operation Modes

CR Number	Parameter	Operation Modes							
		JOG	Zero Return	1st-speed	Interrupt 1st-speed	2nd-speed	Interrupt 2nd-speed	Variable speed	MPG
#2	#1 A								
#4	#3 B								
#7	#6 Vmax								
#9	#8 Vbias								
#11	#10 Vjog								
#13	#12 VRT								
#15	#14 VCR								
#17	#16 N								
#18	#17 P								
#20	#18 Zero return mode								
#21	#19 Home position								
#22	#21 Tacc								
#24	#22 Tdec								
#26	#23 P(I)								
#28	#25 V(I)								
#30	#27 P(II)								
#31	#29 V(II)								
#32	#31 Running instruction								
#34	#33 CP(PLS)								
#36	#35 CS(PPS)								
#40	#40 Numerator of electrical gear								
#41	#41 Denominator of electrical gear								
#43	#42 MPG input frequency								
#45	#44 Accumulated MPG input pulse								
#46	#46 MPG response speed								

6 Error Code & Troubleshooting

It indicates 01PU hardware malfunction or error parameter setting when error LED flashes. ERR code is recorded in CR#39.

Error code	Description	Error code	Description
H'0000	No error	H'0013	Zero return deceleration (VRT) setting error
H'0001	Target position (I) setting error	H'0014	JOG speed (Vjog) setting error
H'0002	Target address (II) setting error	H'0020	CW pulse is forbidden
H'0010	Running speed (I) setting error	H'0021	CCW pulse is forbidden
H'0011	Running speed (II) setting error	H'0080	Hardware error in internal memory
H'0012	Zero return deceleration (VCR) setting error	H'0081	Data write in error in internal memory