

SANMOTION

DC SERVO SYSTEMS

T



SANYO DENKI

Ver.3

CONCEPT
1

Simplified Setup Process for Optimum Operating Conditions

Auto-Tuning

A new auto-tuning algorithm improves system response by providing functions such as inertia identification, 5 auto-tuning modes, 30 levels of response, and parameter setting auto-save.

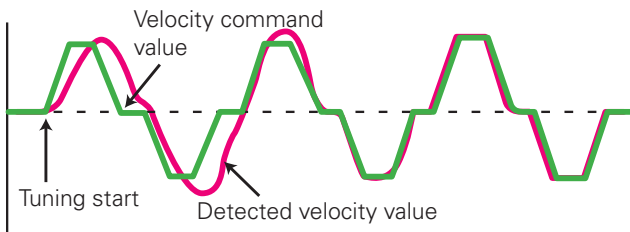

Test Function (JOG)

On-board JOG operation function is available for testing servo motor and servo amplifier connection without the need to connect to host device.

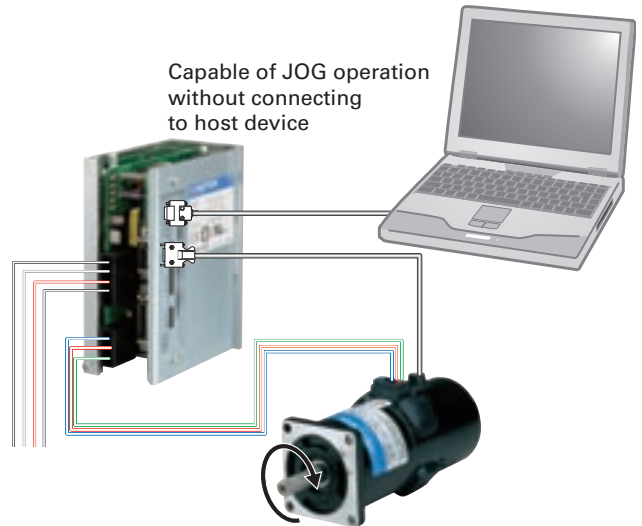

Setup Software is required.

Conformance to Overseas Standards

Our standard servo amplifier has attained the UL, c-UL and EN standards. You can also employ servo motors that have attained the EN standards.



All-in-One Control

Configurable parameters allow you to switch between control modes for torque, position or velocity.

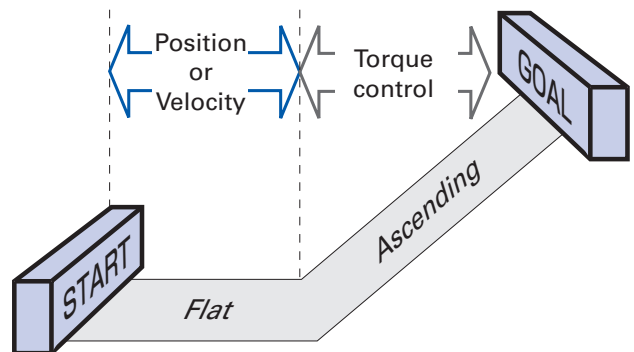

Setup Software

The setup software allows you to set parameters, view graphical displays of monitored position, velocity or torque waveforms, and perform system analysis.

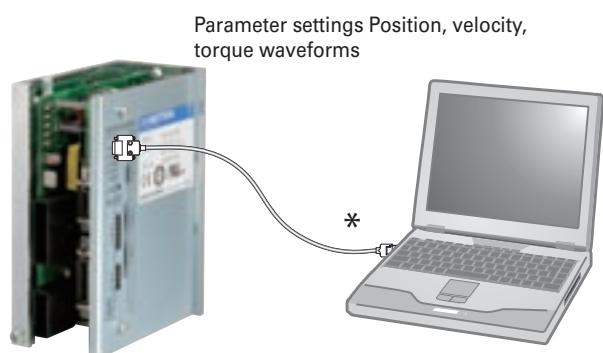

*Use optional cable AL-00490833-01 for PC connection

Multiaxial Monitor Function

The setup software allows up to 15 servo amplifiers to be monitored.



*Use optional cable For PC connection

Protection Code IP43

Protection code is IP43 for all models.



Shaft feedthrough and cable end are excluded.

CONCEPT
2

Improved Systems Precision and Shortened Cycle Time

High Response

A 4th-order notch filter reduces phase delay to suppress mechanical resonance and improve velocity response of equipment.

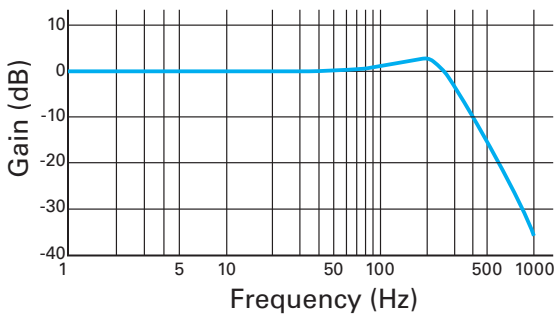

Vibration-damping Control

With feed-forward vibration suppression control, vibrations at the processing point and base of a machine can be suppressed through simple tuning procedures. Up to 4 types of vibration control frequencies can be selected.

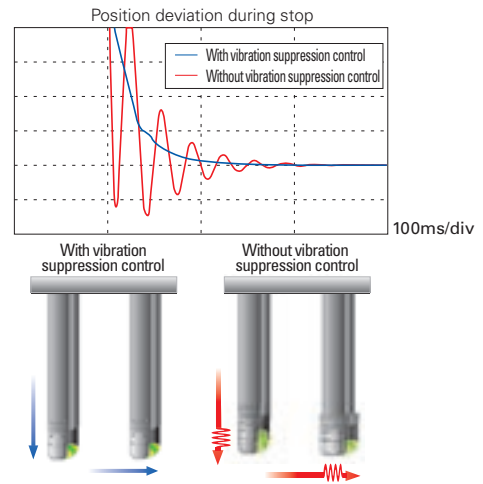

17-bit absolute encoder is required.

Shorter Position Settling Time

A new algorithm drastically shortens positioning settling time for equipment.

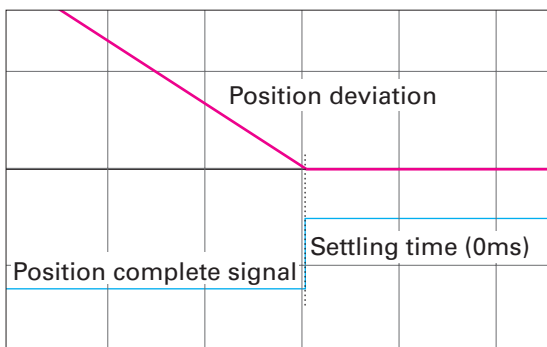

Example of positioning settling time 5ms/div in highly rigid machinery

Disturbance Suppression

It is possible to control impacts from other axes in case of multiaxial constitution, by using the new disturbance observer with extended applicable frequency.

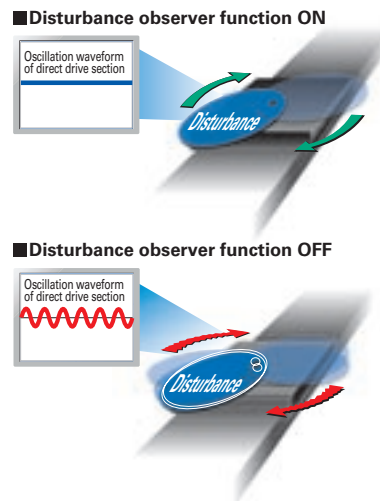

17-bit encoder is required.

CONCEPT
3

Curtailed Running Cost

High Resolution

Control suitable for the high-resolution incremental encoder and absolute encoder can be performed.

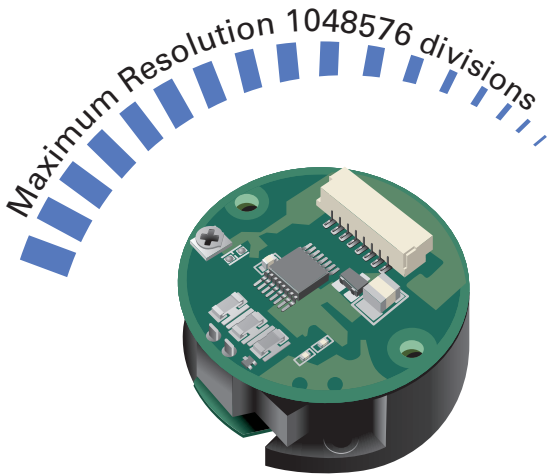

30% Reduction in Power Loss

A low-power loss module has been employed to reduce the power loss in the main circuit by 30%.

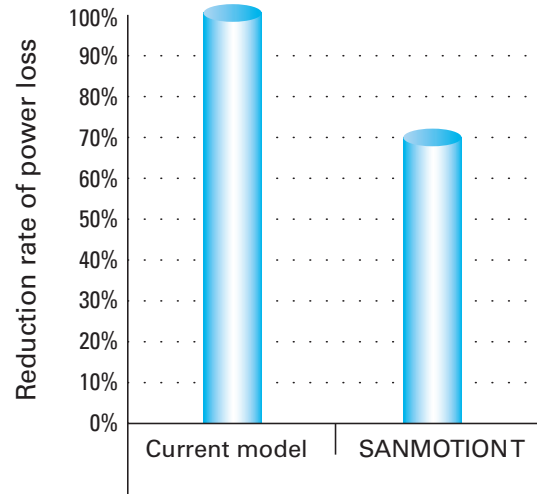

Features and Functions

Model Number Nomenclature

System Configuration

Standard Specifications

External Wiring Diagram

Dimensions

Setup Software

Optional Equipment

Servo Motor Standard Model Number List

Rated Output	Outer diameter of motor	Encoder	Tachometer generator	Winding specifications	Model No.
23W	φ41mm	—	—	24V System	T402-011
		—	With		T402T-011
		Incremental encoder (PP031) 1000P/R	—		T402-011EL8
40W	φ41mm	—	—	24V System	T404-011
		—	With		T404T-011
		—	—	75V System	T404-012
		—	With		T404T-012
		Incremental encoder (PP031) 1000P/R	—	24V System	T404-011EL8
		—	—	75V System	T404-012EL8
60W	φ41mm	—	—	24V System	T406-011
		—	—	75V System	T406-012
		—	With	24V System	T406T-011
		—	With	75V System	T406T-012
		Incremental encoder (PP031) 1000P/R	—	24V System	T406-011EL8
	φ51mm	—	—	75V System	T406-012EL8
		—	—	24V System	T506-011
		—	—	75V System	T506-012
		—	With	24V System	T506T-011
		—	With	75V System	T506T-012
Incremental encoder (PP031) 1000P/R	—	24V System	T506-011EL8		
110W	φ51mm	—	—	75V System	T511-012
		—	With		T511T-012
		Incremental encoder (PP031) 1000P/R	—		T511-012EL8
200W	φ76mm	—	—	75V System	T720-012
		—	With		T720T-012
		Incremental encoder (PP031) 1000P/R	—		T720-012EL8
300W	φ76mm	—	—	75V System	T730-012
		—	With		T730T-012
		Incremental encoder (PP031) 1000P/R	—		T730-012EL8
400W	φ87.5mm	—	—	75V System	T840-012
		—	With		T840T-012
		Incremental encoder (PP031) 1000P/R	—		T840-012EL8
500W	φ87.5mm	—	—	75V System	T850-012
		—	With		T850T-012
		Incremental encoder (PP031) 1000P/R	—		T850-012EL8

For specifications on other model, please contact us.

Servo Amplifier Standard Model Number List

Main power	Control power	Control system	Amp. capacity	Detector	Model No.
DC140V	DC24V	Pulse train,Speed, Torque	20A	Incremental encoder	TS1A02AA
			25A	Incremental encoder	TS1AA2AA
			30A	Incremental encoder	TS1A03AA
		Speed,Torque	20A	Tachometer generator (Motor model T4)	TS1A02AN
				Tachometer generator (Motor model T5)	TS1A02AP
			25A	Tachometer generator(Motor model T5,T7)	TS1AA2AP
DC50V	DC24V	Pulse train,Speed, Torque	20A	Incremental encoder	TS1B02AA
			25A	Incremental encoder	TS1BA2AA
		Speed,Torque	20A	Tachometer generator (Motor model T4)	TS1B02AN
			25A	Tachometer generator (Motor model T4)	TS1BA2AN
				Tachometer generator (Motor model T5)	TS1BA2AP

For specifications on other model, please contact us.

Power unit

Output capacity	Model No.
5A	TS1PA0500
10A	TS1PA1000
15A	TS1PA1500

Features and
Functions

Model Number
Nomenclature

System
Configuration

Standard
Specifications

External Wiring
Diagram

Dimensions

Setup Software

Optional
Equipment

Servo Motor / Power Unit Model Number Nomenclature

Servo Motor

Example : The model number is as follows when 200W rated output, 76mm outer diameter, incremental encoder (1000P/R), a brake, tachometer generator, gear (1/15 gear ratio), and 75V series voltage specification are selected for "SANMOTION" servo motor:

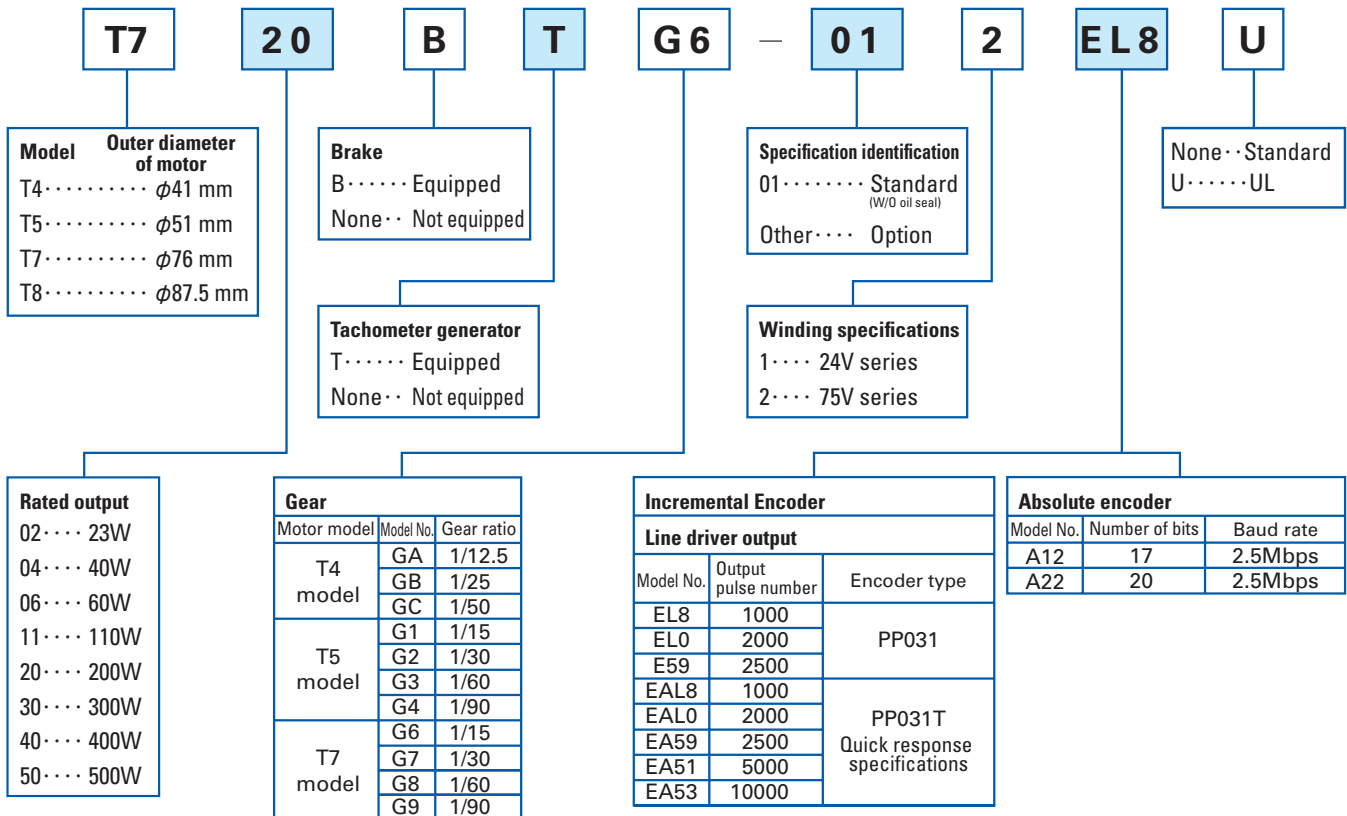

·No indication: No encoder

※T4 type can be equipped with either tacho-generator or encoder only. It cannot be equipped with brake oil seal.

※Motors with a rated output of 23W, 40W, and 60W support the 24V winding specification.

Power Unit

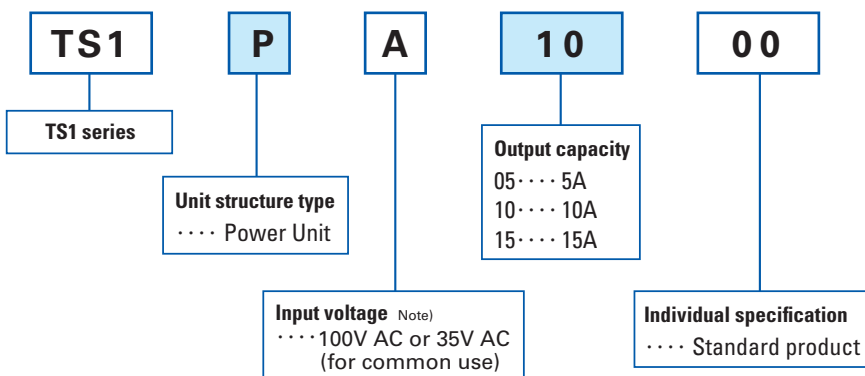

Note) Supply AC100V if the motor winding specification is 75V series and supply AC35V if it is 24V series.

Servo Amplifier Model Number Nomenclature

Servo Amplifier

Example: The model number is as follows when "SANMOTION T "series servo amplifier with input voltage of DC140V, 20A capacity, and incremental encoder (1000P/R).

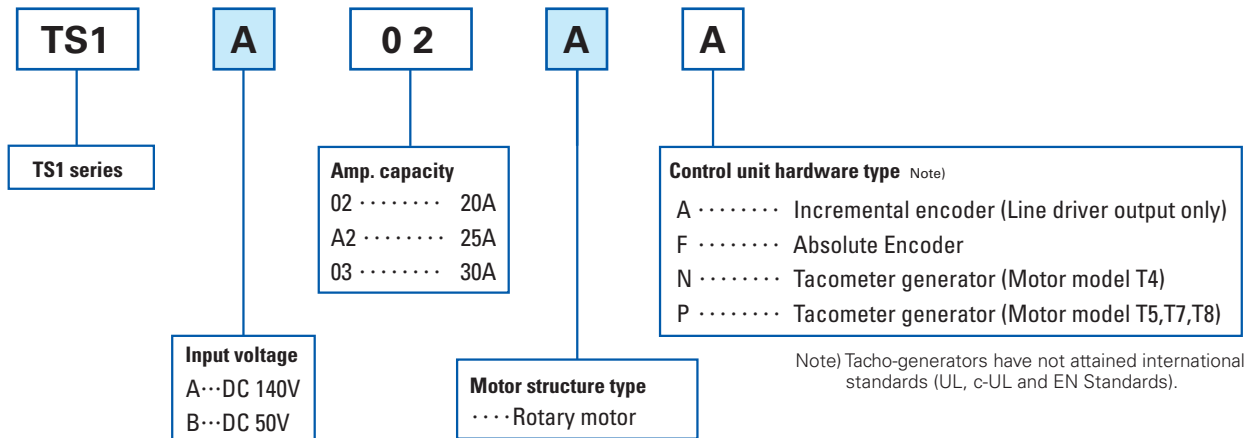

1)Compatible servo motor type^{Note)}

Input voltage-140V DC		
Type of Amplifier.	Type of Motor	Factory settings
TS1A02A	T404-012	√
	T406-012	
	T506-012	
TS1AA2A	T511-012	√
	T720-012	
	T730-012	
TS1A03A	T840-012	√
	T850-012	

Input voltage-50V DC		
Type of Amplifier.	Type of Motor	Factory settings
TS1B02A	T402-011	√

2)Compatible encoder type^{Note)}

Incremental encoder				
Format	Divisions per rotation [P/R]	Addressiation	Hard type.	Factory settings
Optical	1000	INC-E	A	√
Optical	2000	INC-E	A	
Optical	2500	INC-E	A	

Absolute encoder							
Format	Transmission format	Divisions per rotation [P/R]	Multiple rotation	Addressiation	Hard type.	Remarks	Factory settings
Optical	Half duplex start-stop synchronization 2.5M	17bit	16bit	PA035C-2.5MH	F		√

3)Compatible tacometer generator

Motor Model	Tacometer generator Model	Hard type
T4	3V / 1000min ⁻¹	N
T5, T7, T8	7V / 1000min ⁻¹	P

4)Interface for control section^{Note)}

Control type	Factory settings
Velocity control type	√
Torque control type	
Position control type	
Velocity - Torque switch type	
Position - Torque switch type	
Position - Velocity switch type	
Internal velocity control type	

Note) Please change the compatible servo motor, compatible encoder and the interface for control section using the set-up software.

Features and Functions

Model Number Nomenclature

System Configuration

Standard Specifications

External Wiring Diagram

Dimensions

Setup Software

Optional Equipment

System Configuration

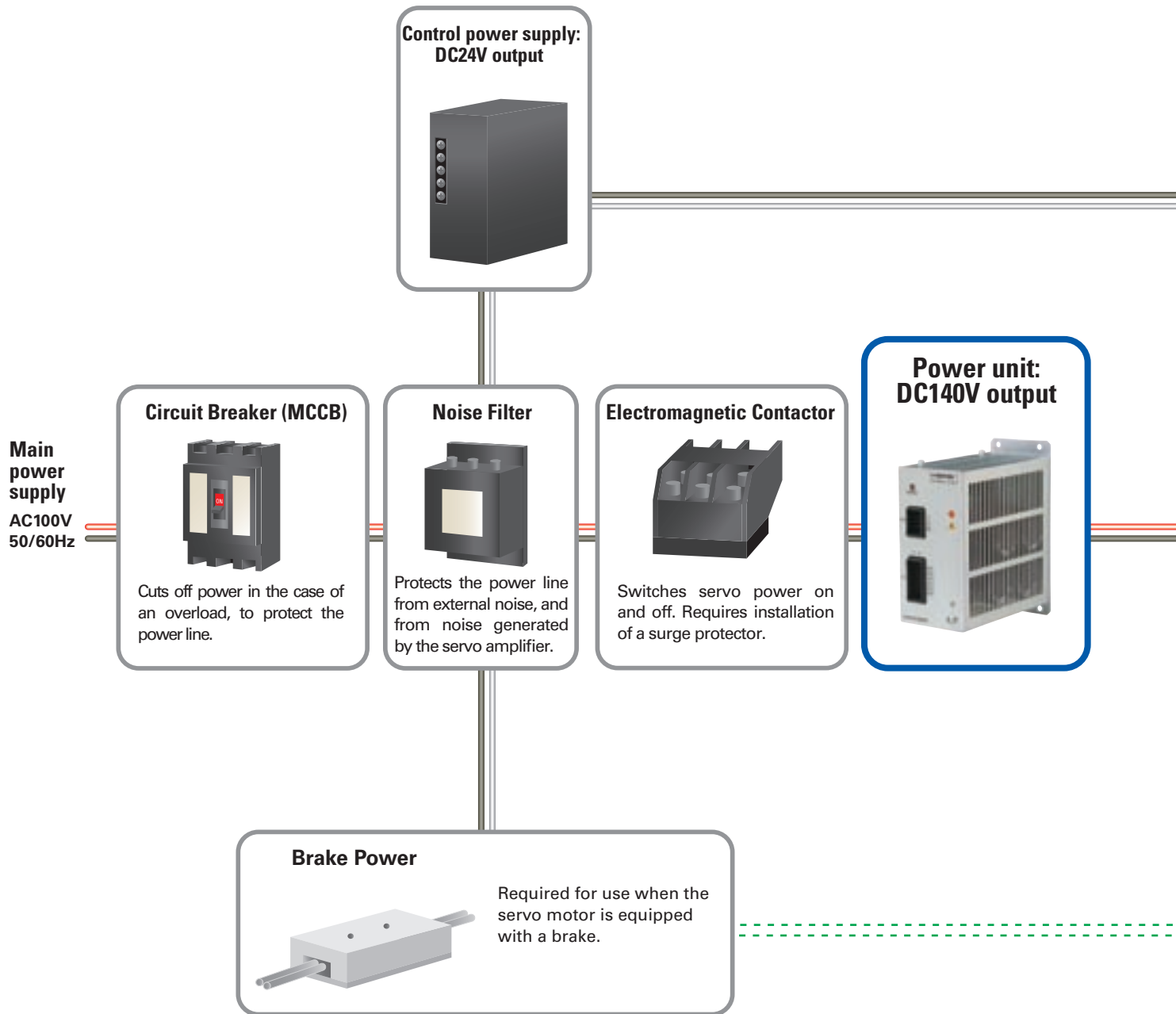

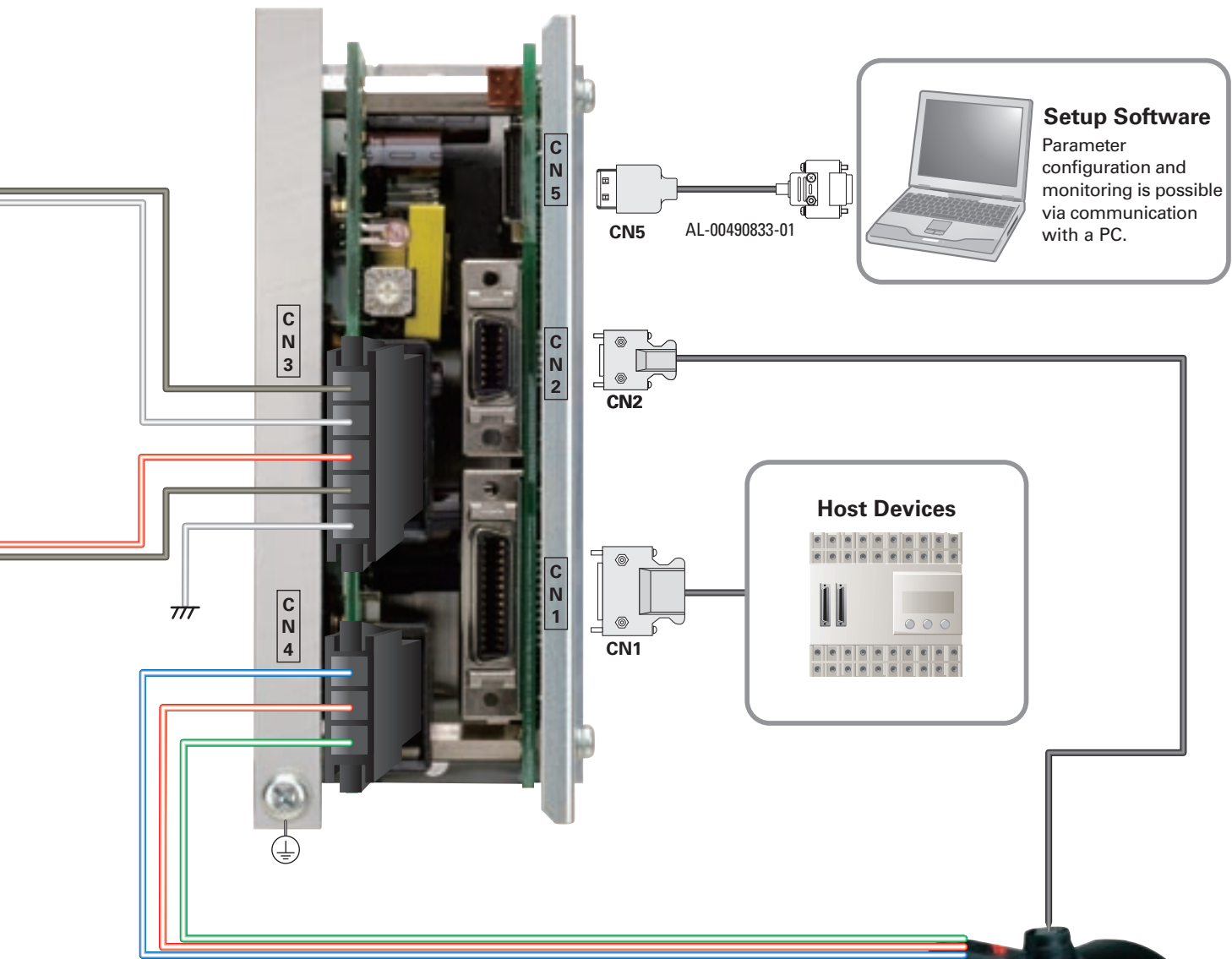

Wiring required for brake.



Servo amplifier + Servo motor

Applicable amplifier model No.				TS1B02AA	TS1A02AA
Motor Model No.				T402-011EL8	T404-012EL8
	Condition	Symbol	Unit (SI)		
Servo amplifier Input power(Control circuit)				DC24V +10, -15%	
Servo amplifier Input power(Main circuit)				DC50V +10, -15%	DC140V +10, -15%
Amplifier operation temperature and humidity				Temperature: 0 to 55°C Humidity: Maximum 90% (no condensation)	
Power capacity(Rated)			kVA	0.2	0.2
Amplifier mass			kg	0.45	
Rated output	★	P_R	W	23	40
Rated speed	★	N_R	min^{-1}	3000	
Maximum speed	★	N_{max}	min^{-1}	3000	
Rated torque	★	T_R	$\text{N} \cdot \text{m}$	0.061	0.080
Continuous stall torque	★	T_S	$\text{N} \cdot \text{m}$	0.070	0.120
Instantaneous maximum stall torque	★	T_{PS}	$\text{N} \cdot \text{m}$	0.206	0.319
Rated armature voltage	★	E_R	V	20	72
Rated armature current	★	I_R	A	1.9	1.0
Continuous stall armature current	★	I_S	A	1.9	0.9
Instantaneous maximum stall armature current	★	I_P	A	4.9	2.1
Torque constant	☆	K_T	$\text{N} \cdot \text{m}/\text{A}$	0.047	0.174
Voltage constant per phase	☆	K_E	$\text{V}/\text{kmin}^{-1}$	4.9	18.2
Phase resistance	☆	R_b	Ω	3.2	18.6
Rated power rate	★	O_R	kW/s	1.2	2.1
Electrical time constant	☆	t_c	ms	0.35	0.35
Mechanical time constant	☆	t_m	ms	7.1	4.8
Load inertia		J_L	$\text{kg} \cdot \text{m}^2(\text{GD}^2/4)$	0.16×10^{-4}	0.27×10^{-4}
Encoder pulse number (output circuit system)			P/R	1000(Line driver)	
Rotor inertia (including sensor)		J_M	$\text{kg} \cdot \text{m}^2(\text{GD}^2/4)$	0.055×10^{-4}	0.092×10^{-4}
Motor mass (including sensor)			kg	0.55	0.65
Break-holding torque	★	T_B	$\text{N} \cdot \text{m}$	—	—
Break excitation voltage	☆	V_B	V	—	—
Break excitation current	☆	I_B	A	—	—
Break inertia		J_B	$\text{kg} \cdot \text{m}^2(\text{GD}^2/4)$	—	—
Break mass			kg	—	—
Motor operation temperature and humidity				Temperature: 0 to 40°C Humidity: Maximum 90% (no condensation)	

- ★ mark indicates a typical value after temperature increased and saturated in the combination with the standard amplifier
- ☆ mark indicates a typical value when the winding temperature is at 25°C.

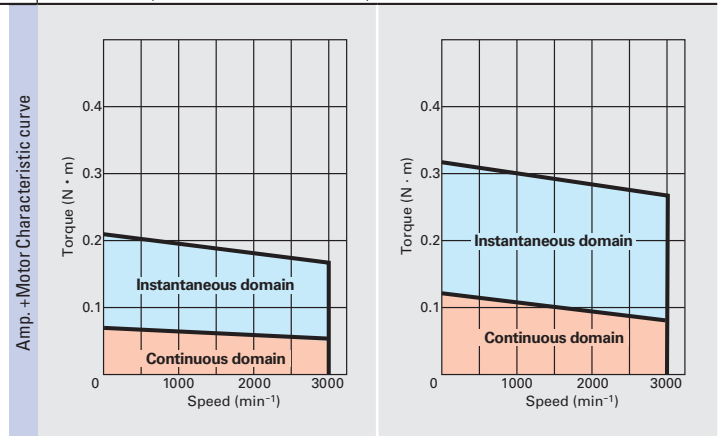

TS1A02AA		TS1AA2AA	
T406-012EL8	T506-012EL8	T511-012EL8	T720-012EL8
DC24V +10, -15%			
DC140V +10, -15%			
Temperature: 0 to 55°C Humidity: Maximum 90% (no condensation)			
0.3	0.3	0.4	0.6
0.45			
60	60	110	200
3000			
3000			
0.137	0.156	0.270	0.605
0.175	0.192	0.358	0.658
0.441	0.441	0.784	1.47
70	75	75	80
1.4	1.2	2.0	3.4
1.4	1.3	2.2	3.7
2.9	2.8	4.5	7.7
0.177	0.183	0.21	0.23
18.5	19.1	21.8	24.2
11.8	12.1	5.1	2.8
3.2	1.7	3.2	2.7
0.37	0.47	0.63	1.1
4.1	7.4	4.3	7.8
0.34×10^{-4}	0.68×10^{-4}	1.13×10^{-4}	4.43×10^{-4}
1000(Line driver)			
0.116×10^{-4}	0.228×10^{-4}	0.378×10^{-4}	1.478×10^{-4}
0.75	0.9	1.2	2.05
—	0.29		1.47
—	90		90
—	0.06		0.11
—	0.01×10^{-4}		0.09×10^{-4}
—	0.26		0.59

Temperature: 0 to 40°C Humidity: Maximum 90% (no condensation)

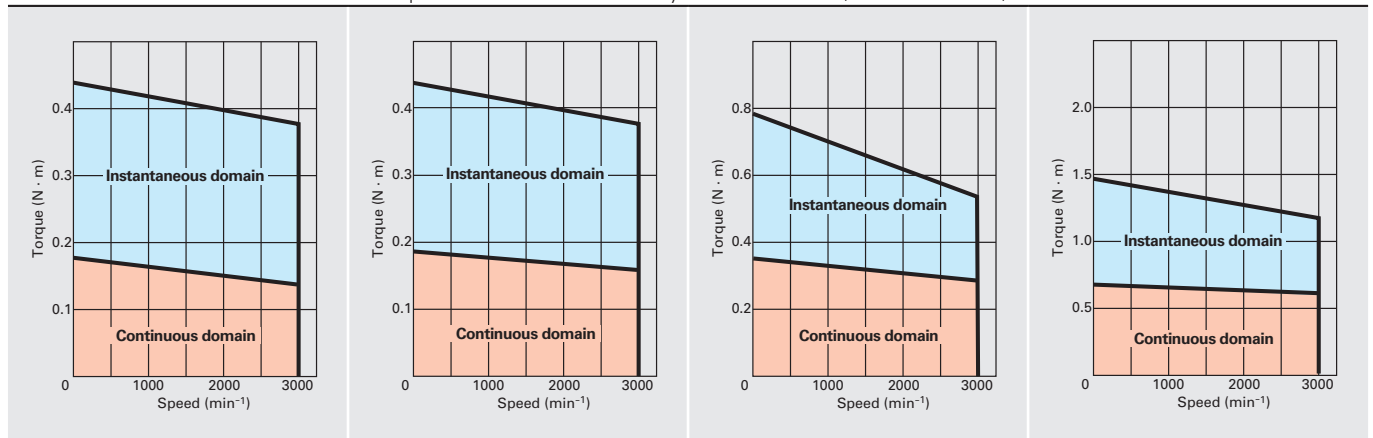

Features and Functions

Model Number Nomenclature

System Configuration

Standard Specifications

External Wiring Diagram

Dimensions

Setup Software

Optional Equipment

Servo amplifier + Servo motor

Applicable amplifier model No.				TS1AA2AA	TS1A03AA
Motor Model No.				T730-012EL8	T840-012EL8
	Condition	Symbol	Unit (SI)		
Servo amplifier Input power(Control circuit)				DC24V +10, -15%	
Servo amplifier Input power(Main circuit)				DC140V +10, -15%	
Amplifier operation temperature and humidity				Temperature: 0 to 55°C Humidity: Maximum 90% (no condensation)	
Power capacity(Rated)			kVA	0.9	1.0
Amplifier mass			kg	0.45	0.65
Rated output	★	P_R	W	300	400
Rated speed	★	N_R	min^{-1}	2500	
Maximum speed	★	N_{max}	min^{-1}	2500	
Rated torque	★	T_R	$\text{N} \cdot \text{m}$	1.00	1.66
Continuous stall torque	★	T_S	$\text{N} \cdot \text{m}$	1.05	1.70
Instantaneous maximum stall torque	★	T_{PS}	$\text{N} \cdot \text{m}$	2.45	3.72
Rated armature voltage	★	E_R	V	75	85
Rated armature current	★	I_R	A	5.2	5.8
Continuous stall armature current	★	I_S	A	5.5	6
Instantaneous maximum stall armature current	★	I_P	A	10.9	13.7
Torque constant	☆	K_T	$\text{N} \cdot \text{m}/\text{A}$	0.273	0.31
Voltage constant per phase	☆	K_E	$\text{V}/\text{kmin}^{-1}$	28.6	32.9
Phase resistance	☆	R_b	Ω	1.1	0.95
Rated power rate	★	O_R	kW/s	5.1	5.0
Electrical time constant	☆	t_c	ms	1.5	2.0
Mechanical time constant	☆	t_m	ms	4.0	5.2
Load inertia		J_L	$\text{kg} \cdot \text{m}^2(\text{GD}^2/4)$	8.12×10^{-4}	15×10^{-4}
Encoder pulse number (output circuit system)			P/R	1000(Line driver)	
Rotor inertia (including sensor)		J_M	$\text{kg} \cdot \text{m}^2(\text{GD}^2/4)$	2.708×10^{-4}	5.008×10^{-4}
Motor mass (including sensor)			kg	2.75	3.65
Break-holding torque	★	T_B	$\text{N} \cdot \text{m}$	1.47	1.96
Break excitation voltage	☆	V_B	V	90	90
Break excitation current	☆	I_B	A	0.11	0.11
Break inertia		J_B	$\text{kg} \cdot \text{m}^2(\text{GD}^2/4)$	0.09×10^{-4}	0.2×10^{-4}
Break mass			kg	0.59	0.79
Motor operation temperature and humidity				Temperature: 0 to 40°C Humidity: Maximum 90% (no condensation)	

- ★ mark indicates a typical value after temperature increased and saturated in the combination with the standard amplifier
- ☆ mark indicates a typical value when the winding temperature is at 25°C.

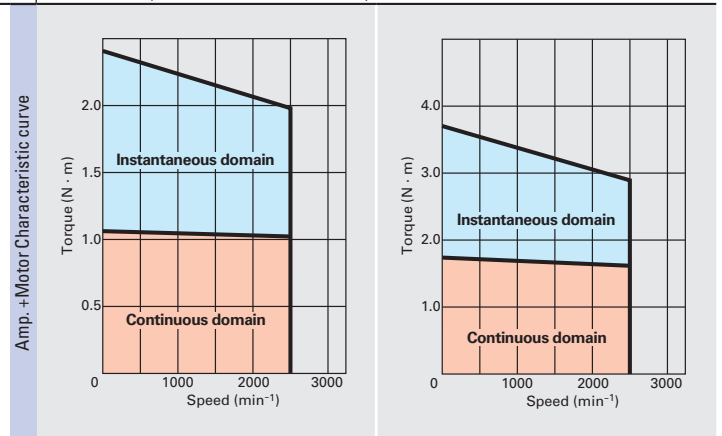

TS1A03AA
T850-012EL8
DC24V +10, -15%
DC140V +10, -15%
The same as the left
1.3
0.65
500
2500
2500
1.76
1.90
4.21
80
7.6
7.6
17.6
0.287
30
0.56
6.4
1.9
4.1
18×10^{-4}
1000(Line driver)
6.008×10^{-4}
4.25
1.96
90
0.11
0.2×10^{-4}
0.79
The same as the left

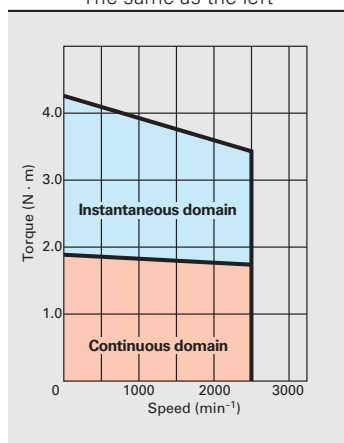

Power Unit specifications

Applicable Power unit model No.	Unit	TS1PA05	TS1PA10	TS1PA15
Power unit Input voltage	V	AC100V +10%,-15% or AC35V +10%,-15%		
Power unit rated output current	A	5	10	15
Power unit operation temperature and humidity		Temperature: 0 to 55°C Humidity: Maximum 90% (no condensation)		
Power capacity(Rated) at AC100V input	KVA	1.4	2.8	4.2
Power unit weight	Kg	0.70	0.75	0.80

Features and Functions

Model Number Nomenclature

System Configuration

Standard Specifications

External Wiring Diagram

Dimensions

Setup Software

Optional Equipment

Servo motor

Model					T402-011	T404-012	
	Condition	Symbol	Unit (SI)				
Motor	Rated output	☆☆	PR	W	23	40	
	Rated armature voltage	☆☆	VR	V	20	72	
	Rated torque	☆☆	TR	N·m	0.074	0.13	
	Rated armature current	☆☆	IR	A	1.9	1.0	
	Rated rotating speed	☆☆	NR	min ⁻¹	3000		
	Continuous stall torque	☆☆	TS	N·m	0.08	0.14	
	Instantaneous maximum torque	☆☆	TP(N)	N·m	0.42	0.76	
	Stall armature current	☆☆	IS	A	1.9	0.9	
	Instantaneous maximum armature current	☆☆	IP(N)	A	10	4.7	
	Maximum rotating speed		Nmax	min ⁻¹	5000		
	Friction torque	☆	Tf	N·m	0.015	0.019	
	Rated power rate	☆☆	QR	kW/S	1.2	2.1	
	Instantaneous maximum angular acceleration	☆☆	αP	rad/s ²	89.4×10 ³	90.5×10 ³	
	Viscous braking constant	☆	Fd	N·m/min ⁻¹	0.003×10 ⁻³	0.006×10 ⁻³	
	Torque constant	☆	KT	N·m/A	0.047	0.174	
	Voltage constant	☆	KE	V/min ⁻¹	4.9×10 ⁻³	18.2×10 ⁻³	
	Rotor inertia		JM	kg·m ²	0.0047×10 ⁻³	0.0084×10 ⁻³	
	Armature winding resistance	☆	Ra	Ω	3.2	18.6	
	Armature inductance	☆	Ja	mH	1.1	6.6	
	Mechanical time constant	☆	tm	ms	7.1	4.8	
	Electrical time constant	☆	te	ms	0.35	0.35	
	Thermal time constant	☆☆	tθ	min	15	20	
	Thermal resistance	☆☆	Rθ	K/W	4.9	3.6	
	Heatup limit	☆☆	θ	K	105		
Mass		W/M	kg	0.3	0.4		
Tachogenerator	Coefficient of voltage generated	☆	KEG	V/min ⁻¹	3×10 ⁻³ ±10%		
	Effective (rms) ripple	☆	εs	%	2		
	Peak-to-peak ripple	☆	εs	%	5		
	Linearity	☆	δL	%	1		
	Armature winding resistance	☆	Ri	Ω	37		
	Armature inductance	☆	Li	mH	5		
	Minimum load resistance	☆	RL	kΩ	10		
	Rotor inertia		JTG	kg·m ²	0.0011×10 ⁻³		
	Mass		WT	kg	0.09		
	Holding brake	Holding torque	☆☆	TB	N·m	—	
		Voltage	☆	VB	V DC	—	
Current		☆	IB	A	—		
Resistance		☆	RB	Ω	—		
Inertia			JB	kg·m ²	—		
Mass			WB	kg	—		
Optical encoder pulse number	Open collector			200 500 1000 P/R			
	Line driver			1000 2000 2500 5000 10000 P/R			
Gear				1/12.5 1/25 1/50			
Oil seal				—			

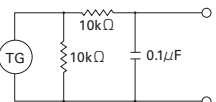
- Note 1) The mark * in the "Condition" column is a value that applies when the ambient temperature and armature winding temperature are 25°C. The mark * is a value that applies when the temperature has risen to the limit.
- 2) The figures in the above table apply when a smooth DC power supply is used at an ambient temperature of no more than 40°C.
- 3) The characteristics of the tachogenerator are based on the use of a test circuit illustrated below.
- 
- 4) The values in the above table were measured when a specific device was mounted on an aluminum plate. T4 type, T5 type (200mm Height × 200mm width × 12mm thick), and T7 and T8 type (305mm Height × 305mm width × 12mm thick).
- 5) No encoder can be installed on a T4 type equipped with a tachogenerator.
- 6) Do not use a holding brake for quick braking.
- 7) The T404 and T406 series are compatible with products having a rated voltage ER of 24V.
- 8) The brake can be of the 24V type (optional).

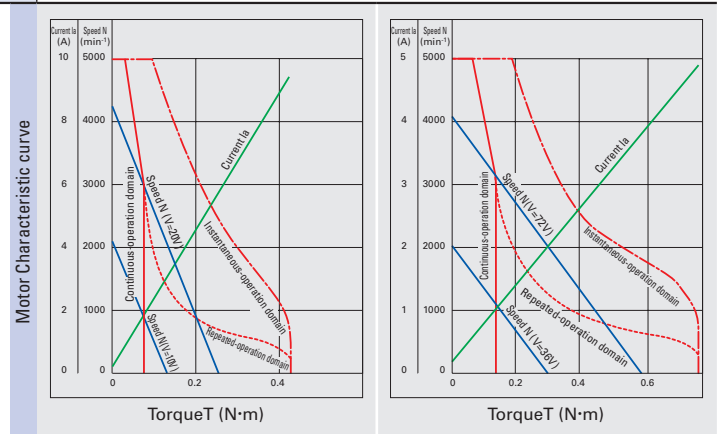

T406-012	T506-012	T511-012	T720-012
60	60	110	200
70		75	80
0.19	0.19	0.34	0.64
1.4	1.2	2.0	3.4
3000		3000	3000
0.20	0.24	0.42	0.77
1.2	1.8	3.4	5.4
1.4	1.3	2.2	3.7
7.6	10	18	25
5000		5000	5000
0.020	0.02	0.022	0.04
3.2	1.7	3.2	2.7
111×10^3	81.8×10^3	91.9×10^3	36.7×10^3
0.008×10^{-3}	0.009×10^{-3}	0.013×10^{-3}	0.020×10^{-3}
0.177	0.183	0.21	0.23
18.5×10^{-3}	19.1×10^{-3}	21.8×10^{-3}	24.2×10^{-3}
0.0108×10^{-3}	0.022×10^{-3}	0.037×10^{-3}	0.147×10^{-3}
11.8	12.1	5.1	2.8
4.4	5.7	3.2	3.0
4.1	7.4	4.3	7.8
0.37	0.47	0.63	1.1
25	20	30	30
3.0	2.8	2.4	1.2
105		105	105
0.5	0.65	0.95	1.8
$3 \times 10^{-3} \pm 10\%$		$7 \times 10^{-3} \pm 10\%$	
2		1	
5		3	
		1	
37		26	
5		4.1	
		10	
0.0011×10^{-3}		0.012×10^{-3}	
0.09		0.26	0.35
—		0.29	1.47
—		90	90
—		0.06	0.11
—		1600	820
—		0.001×10^{-3}	0.009×10^{-3}
—		0.26	0.59
		200 500 1000 P/R	
		1000 2000 2500 5000 10000 P/R	
1/12.5 1/25 1/50		1/15 1/30 1/60 1/90	
—		Installable	

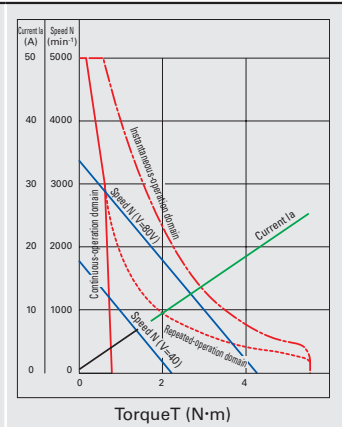
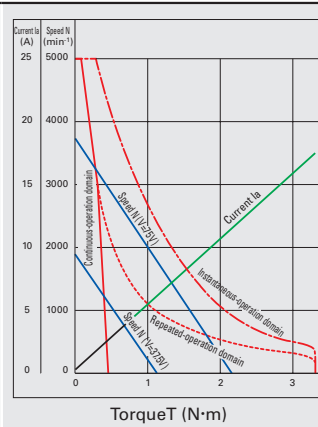
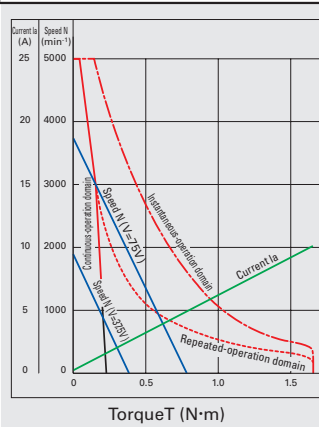
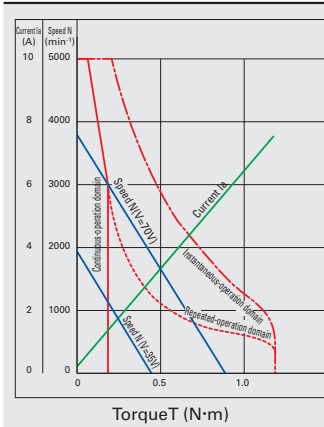

Features and Functions

Model Number Nomenclature

System Configuration

Standard Specifications

External Wiring Diagram

Dimensions

Setup Software

Optional Equipment

Specification

Servo motor

Model					T730-012	T840-012
	Condition	Symbol	Unit (SI)			
Motor	Rated output	☆☆	PR	W	300	400
	Rated armature voltage	☆☆	VR	V	75	85
	Rated torque	☆☆	TR	N·m	1.18	1.57
	Rated armature current	☆☆	IR	A	5.2	5.8
	Rated rotating speed	☆☆	NR	min ⁻¹	2500	
	Continuous stall torque	☆☆	TS	N·m	1.43	1.70
	Instantaneous maximum torque	☆☆	TP(N)	N·m	9.8	12.0
	Stall armature current	☆☆	IS	A	5.5	6.0
	Instantaneous maximum armature current	☆☆	IP(N)	A	40	40
	Maximum rotating speed		Nmax	min ⁻¹	4000	4000
	Friction torque	☆	Tf	N·m	0.05	0.06
	Rated power rate	☆☆	QR	kW/S	5.1	5.0
	Instantaneous maximum angular acceleration	☆☆	αP	rad/s ²	38.4×10 ³	24×10 ³
	Viscous braking constant	☆	Fd	N·m/min ⁻¹	0.039×10 ⁻³	0.045×10 ⁻³
	Torque constant	☆	KT	N·m/A	0.273	0.314
	Voltage constant	☆	KE	V/min ⁻¹	28.6×10 ⁻³	32.9×10 ⁻³
	Rotor inertia		JM	kg·m ²	0.270×10 ⁻³	0.50×10 ⁻³
	Armature winding resistance	☆	Ra	Ω	1.1	0.95
	Armature inductance	☆	Ja	mH	1.6	1.9
	Mechanical time constant	☆	tm	ms	4.0	5.2
	Electrical time constant	☆	te	ms	1.5	2.0
	Thermal time constant	☆☆	tθ	min	30	30
	Thermal resistance	☆☆	Rθ	K/W	1.2	1.1
Heatup limit	☆☆	θ	K	105	105	
Mass		W/M	kg	2.5	3.4	
Tachogenerator	Coefficient of voltage generated	☆	KEG	V/min ⁻¹	7×10 ⁻³ ±10%	
	Effective (rms) ripple	☆	εs	%	1	
	Peak-to-peak ripple	☆	εs	%	3	
	Linearity	☆	δL	%	1	
	Armature winding resistance	☆	Ri	Ω	26	
	Armature inductance	☆	Li	mH	4.1	
	Minimum load resistance	☆	RL	kΩ	10	
	Rotor inertia		JTG	kg·m ²	0.012×10 ⁻³	
	Mass		WT	kg	0.35	0.45
	Holding brake	Holding torque	☆☆	TB	N·m	1.47
Voltage		☆	VB	V DC	90	90
Current		☆	IB	A	0.11	0.11
Resistance		☆	RB	Ω	820	820
Inertia			JB	kg·m ²	0.009×10 ⁻³	0.02×10 ⁻³
Mass			WB	kg	0.59	0.79
Optical encoder pulse number	Open collector			200 500 1000 P/R		
	Line driver			1000 2000 2500 5000 10000 P/R		
Gear				1/15 1/30 1/60 1/90	—	
Oil seal				Installable		

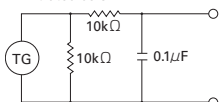
- Note 1) The mark * in the "Condition" column is a value that applies when the ambient temperature and armature winding temperature are 25°C. The mark * is a value that applies when the temperature has risen to the limit.
- 2) The figures in the above table apply when a smooth DC power supply is used at an ambient temperature of no more than 40°C.
- 3) The characteristics of the tachogenerator are based on the use of a test circuit illustrated below.
- 
- 4) The values in the above table were measured when a specific device was mounted on an aluminum plate. T4 type, T5 type (200mm Height × 200mm width × 12mm thick), and T7 and T8 type (305mm Height × 305mm width × 12mm thick).
- 5) No encoder can be installed on a T4 type equipped with a tachogenerator.
- 6) Do not use a holding brake for quick braking.
- 7) The T404 and T406 series are compatible with products having a rated voltage ER of 24V.
- 8) The brake can be of the 24V type (optional).

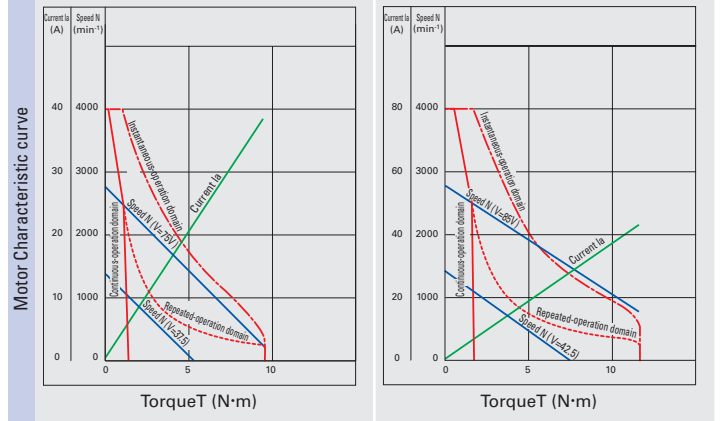

T850-012	
500	
80	
1.96	
7.6	
2500	
2.16	
16.7	
7.6	
62	
3000	
0.07	
6.4	
27.8×10^{-3}	
0.058×10^{-3}	
0.287	
30.0×10^{-3}	
0.60×10^{-3}	
0.56	
1.1	
4.1	
1.9	
40	
1.0	
105	
4.0	
$7 \times 10^{-3} \pm 10\%$	
1	
3	
1	
26	
4.1	
10	
0.012×10^{-3}	
0.45	
1.96	
90	
0.11	
820	
0.02×10^{-3}	
0.79	
200 500 1000 P/R	
1000 2000 2500 5000 10000 P/R	
—	
Installable	

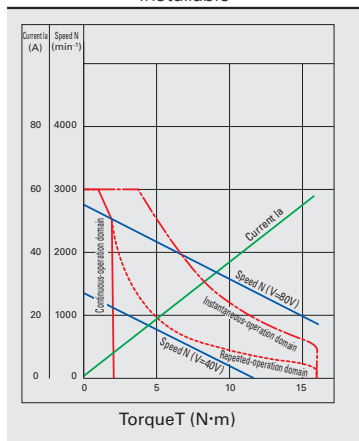

Connection method

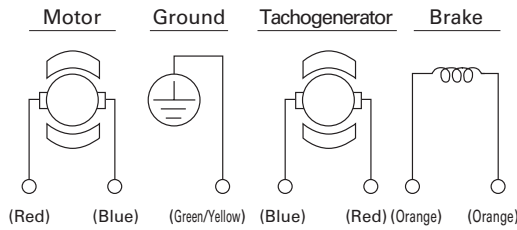

How to run the motor
 Counterclockwise as viewed from the output axis when (red) + (blue) –
 Tachogenerator polarity
 (Red) + (blue) – in counterclockwise rotation as viewed from the output axis

Common specifications

Rating	Continuous ("S1")
Heat resistance class	F (Type A for UL-compliance models)
Excitation system	Permanent magnet
Insulation resistance	10MΩ or more (with a 500 VDC megger)
Dielectric strength	50Hz, 1,500 VAC (600V for 24V and TG types, 1 minute (but do not perform an insulation test between the system and encoder.))
Rotation method	Normal/reverse rotations possible
Ambient temperature	0 to 40°C
Humidity	20 to 90%RH (non-condensing)
Paint color	Black
Protection system	Fully closed (IP43)
Lead wire length	1000mm

Gear Rating

Model No.	Motor nameplate marking		G6 gear	GA	GB	GC
	Gear model			G6-12	G6-25	G6-50
Reduction ratio (nominal)				1/12.5	1/25	1/50
Reduction ratio (detailed)				1/12.5	1/25	1/50
Rated torque	TRG	N·m		0.5	1.0	2.0
Instantaneous	TPG	N·m		1.5	3.0	6.0
Mass	WG	kg		0.4		
Applicable motor				T4 model		

Model No.	Motor nameplate marking		G8 gear	G1	G2	G3	G4
	Gear model			G8-15	G8-30	G8-60	G8-90
Reduction ratio (nominal)				1/15	1/30	1/60	1/90
Reduction ratio (detailed)				1/15.004	1/31.155	1/60.227	1/89.588
Rated torque	TRG	N·m		1.0	2.0	4.0	4.0
Instantaneous	TPG	N·m		3.0	6.0	12.0	12.0
Mass	WG	kg		0.6			
Applicable motor				T5 model			

Model No.	Motor nameplate marking		G10 gear	G6	G7	G8	G9
	Gear model			G10-15	G10-30	G10-60	G10-90
Reduction ratio (nominal)				1/15	1/30	1/60	1/90
Reduction ratio (detailed)				1/15.303	1/30.066	1/60.132	1/90.198
Rated torque	TRG	N·m		3.8	7.5	15.0	15.0
Instantaneous	TPG	N·m		12.0	23.0	45.0	45.0
Mass	WG	kg		1.5			
Applicable motor				T7 model			

Note 1) Do not apply any value exceeding the appropriate rated torque or instantaneous maximum torque.
 2) Applying a value exceeding the appropriate instantaneous maximum torque causes an abnormal thrust load, perhaps resulting in affecting the encoder and other equipment.

Features and Functions

Model Number Nomenclature

System Configuration

Standard Specifications

External Wiring Diagram

Dimensions

Setup Software

Optional Equipment

Standard specifications

Encoder type		PP031T(Quick response specifications)	PP031
Applicable motor type	Unit	T4 ·T5 ·T7 ·T8 model	T4 ·T5 ·T7 ·T8 model
Output pulse number	P/R	1000 1024 1250 2000 2048 2500 4000 4096 5000 8000 8192 10000	200 500 1000 200 500 1000 2000 2500
Rotating disk Slit number		500 512 625	200 500 1000 200 500 1000 2000 2500
Multiplication number		×2 ×4 ×8 ×16	×1
Output circuit system		Line driver	Open collector Line driver
Channel number		3	3
Input voltage	V.DC	+5±10%	+5±10%
Power demand	mA	160max	70max 160max
Output circuit voltage	V.DC	$V_{OH}=2.4min, V_{OL}=0.5max$ at $I_o=\pm 20mA$	+30max (When output transistor off) $V_{OH}=2.4min, V_{OL}=0.5max$ at $I_o=\pm 20mA$
Output circuit current	mA	20max	20max 20max
Response frequency	kHz	0 to 800	0 to 300 0 to 300
Pulse duty cycle		—	$T_1=1/2T_0\pm 1/8T_0$
Output mutual phase difference		R1 to Rn=10 to 50%	$T_{2\ to\ 5}=1/4T_0\pm 1/8T_0$ $(T_{0max}-T_{0min})/T_0\leq 0.08$
Flutter		—	
Working temperature	°C	-10 to +85(at encoder atmosphere)	-10 to +85(at encoder atmosphere)
Light emitting element		Infrared light emitting diode	Infrared light emitting diode
Light receiving element		Photo IC	Photo diode
Inertia	kg·m ²	0.00008×10 ⁻³	200 P/R : 0.00003×10 ⁻³ , 500 ·1000 ·2000 ·2500 P/R : 0.00008×10 ⁻³
Weight	kg	0.25	0.25

External leads

Lead color	Open collector	Line driver
Red	+DC5V	+DC5V
Black	GND(0V)	GND(0V)
Shield	Case earth	Case earth
Blue	A channel output	A channel output
Brown	—	\bar{A} channel output
Green	B channel output	B channel output
Purple	—	\bar{B} channel output
White	—	C channel output
Yellow	C channel output	\bar{C} channel output

Notice

- Never apply shock in the thrust direction when handling the encoder.
- Do not test encoder insulation resistance and dielectric strength to avoid damaging the electronic circuits.
- With respect to line connection for the open collector type, among the colored lead wires, the brown, purple and white lead wires have not been connected.

Output waveform (PP031T Quick response specifications)

●Line driver output

(when rotating in a counterclockwise direction viewed from the motor output axis)

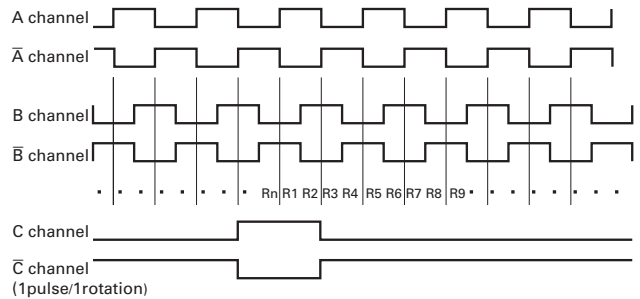

Output cross-phase difference: Rn (n=1 to pulse number x 4)
(Indicate the output cross-phase difference in percentage terms assuming 360 degrees/pulse number to be 100%.)

Output waveform

●Open collector output

(When the encoder rotates counterclockwise viewed from the motor output shaft side)

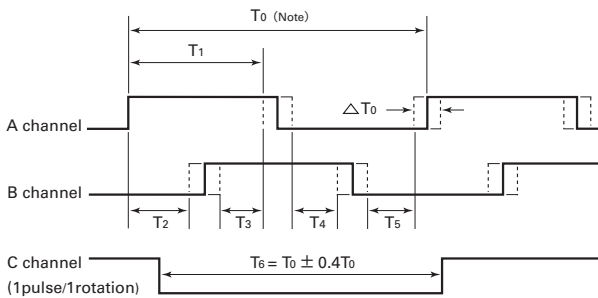

●Line driver output

(When the encoder rotates counterclockwise viewed from the motor output shaft side)

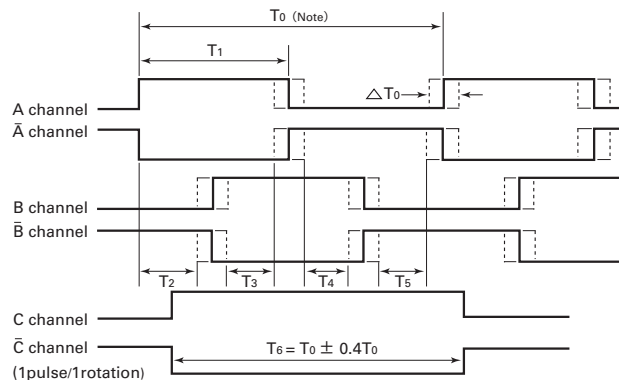

Notice)*T₀* is the average value of each cycle during one encoder rotation at a constant speed.
T₀ : 360-degree electrical angle.

Characteristics of overload duty cycle

When repeatedly driving "SANMOTION T" under an overload as illustrated in the right-hand figure, calculate the operable time t_R on the basis of the characteristic curve of overload duty cycle.

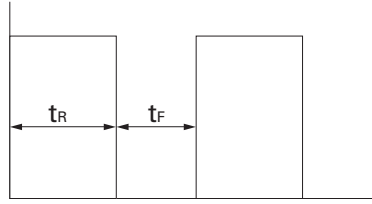

- T_S : Continuous stall torque
- T_L : Load torque
- t_R : Load time (minutes)
- t_F : Rest time (minutes)

$$\text{Load factor} = \frac{T_L}{T_S} \times 100 = \frac{\text{Armature current}}{\text{Stall armature current}} \times 100$$

$$\text{Load time factor, \%ED} = \frac{t_R}{t_R + t_F} \times 100$$

$$\text{Rest time } t_F = t_R \left(\frac{100}{\%ED} - 1 \right)$$

Typical calculations (V850-012)

Supposing that the load factor is 150% and the percentage of ED is 40%, the load time $t_R = 3$ (minutes), from the characteristic curve of overload duty cycle. Therefore,

$$\text{Rest time } t_F = t_R \left(\frac{100}{\%ED} - 1 \right) = 3 \left(\frac{100}{40} - 1 \right) = 4.5 \text{ (minutes)}$$

This means that, if you run the system at an overload of 150% with regard to the continuous stall torque for three minutes, you need a rest time of 4.5 minutes.

T402

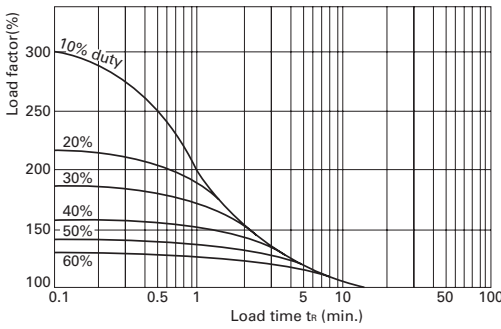

T404, T506

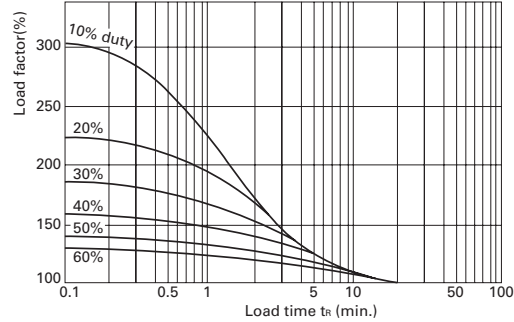

T406

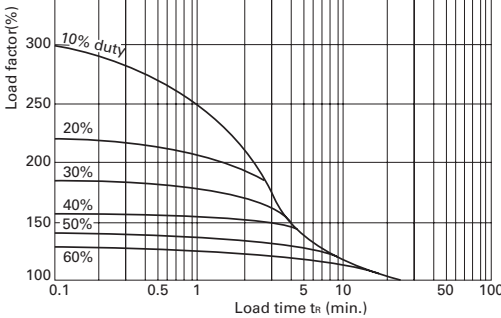

T511, T720, T730, T840

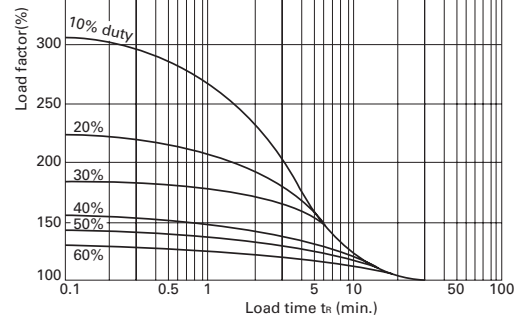

T850

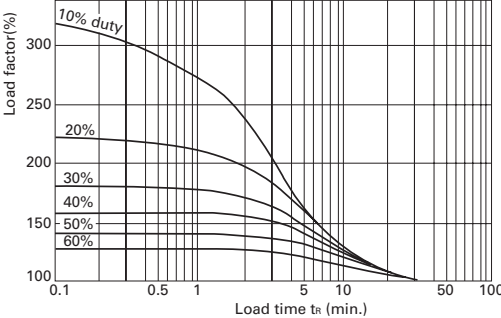

Features and Functions

Model Number Nomenclature

System Configuration

Standard Specifications

External Wiring Diagram

Dimensions

Setup Software

Optional Equipment

External Wiring Diagram

Position command Type

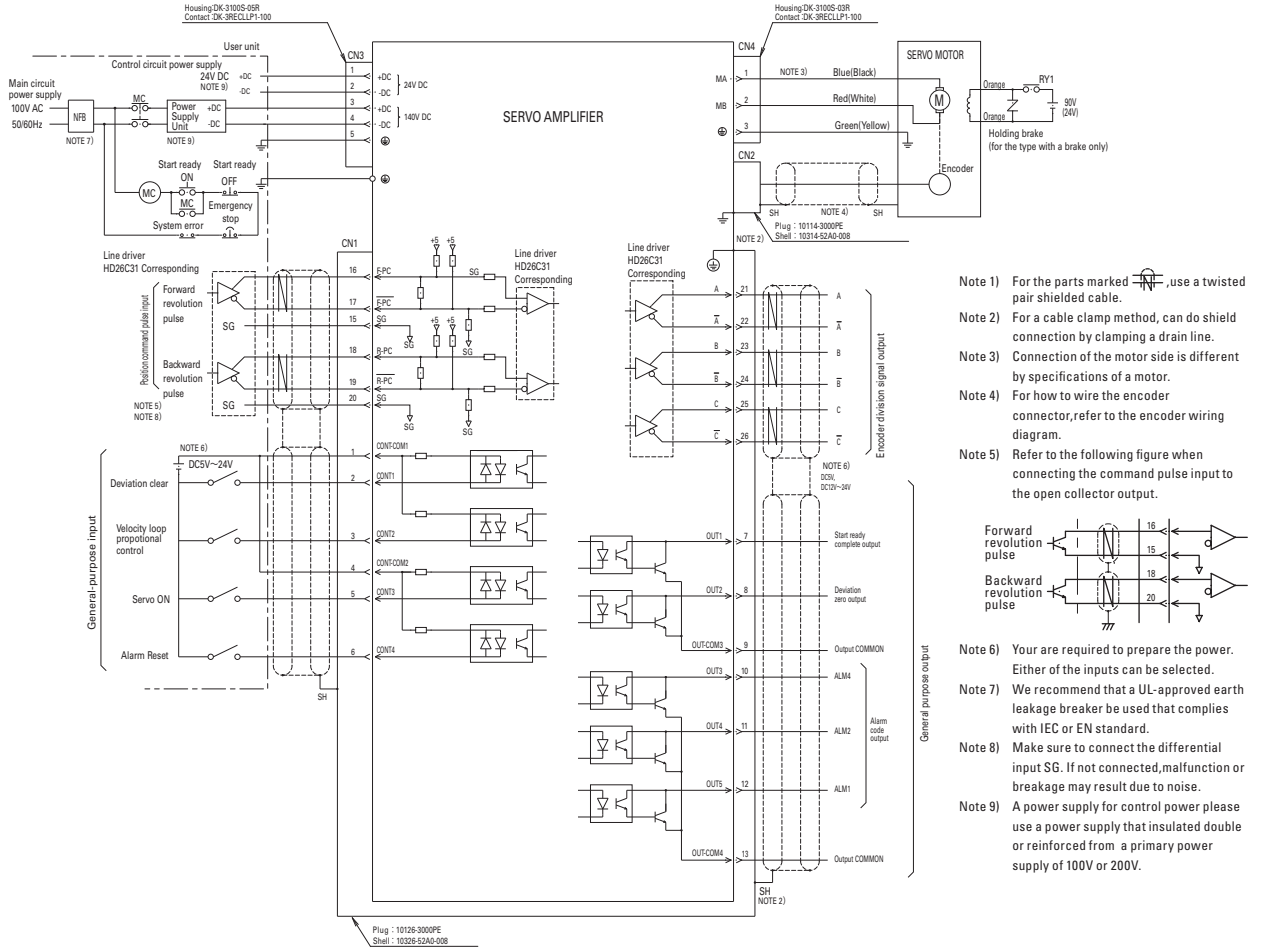

Velocity command/Torque command Type

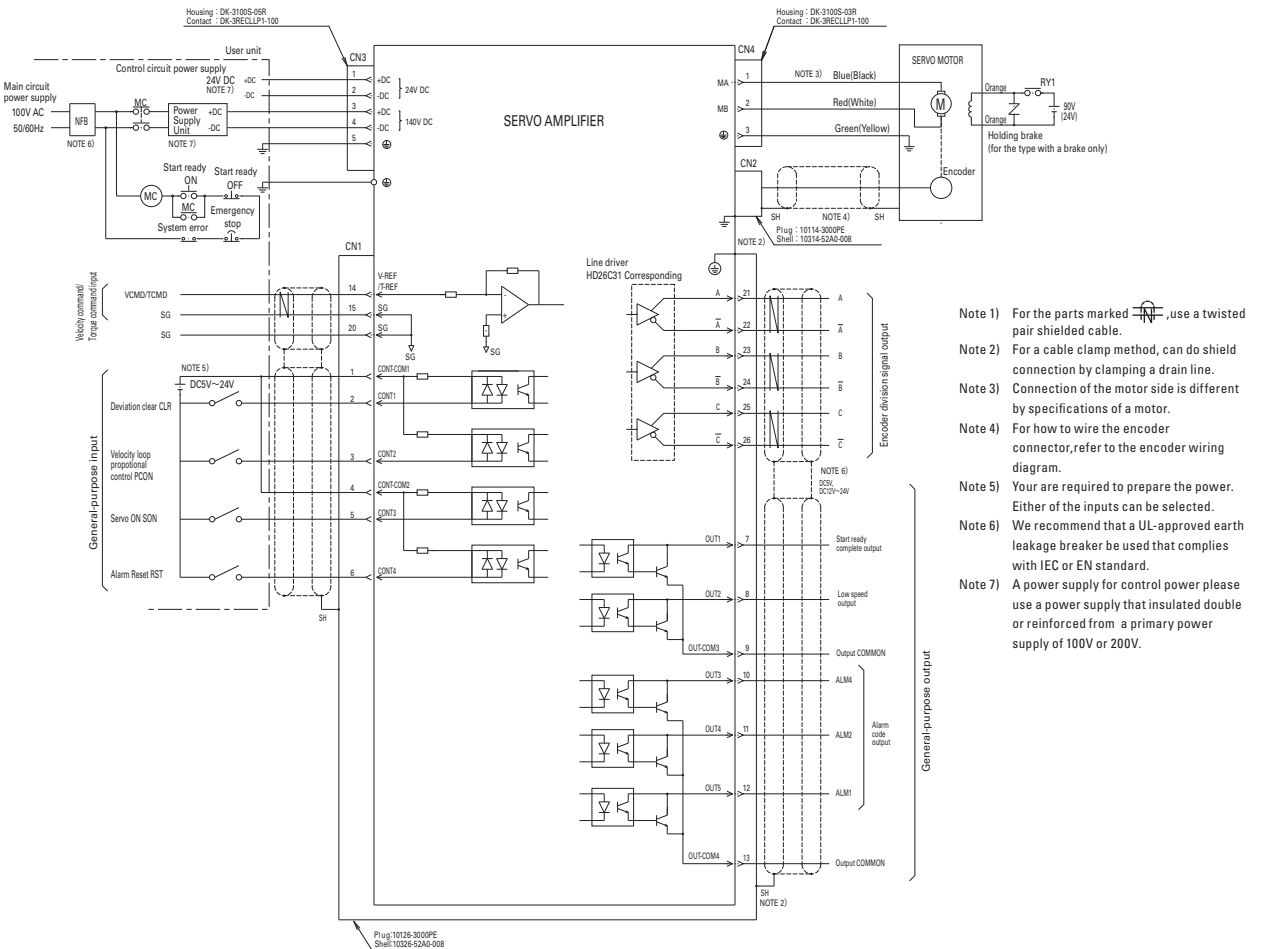

Power Unit / Encoder / Tacometer generator Wiring Diagram

Power Unit

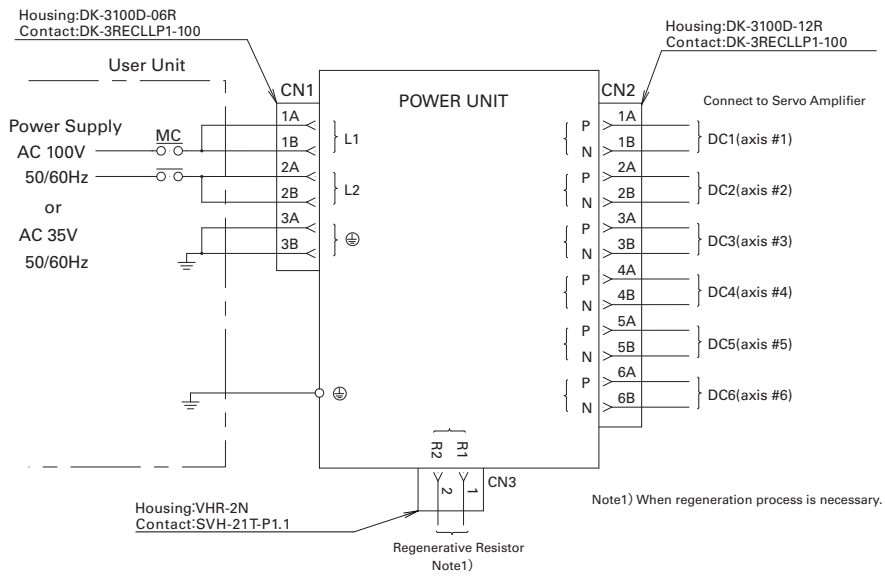

Encoder

Incremental encoder Lead wire type

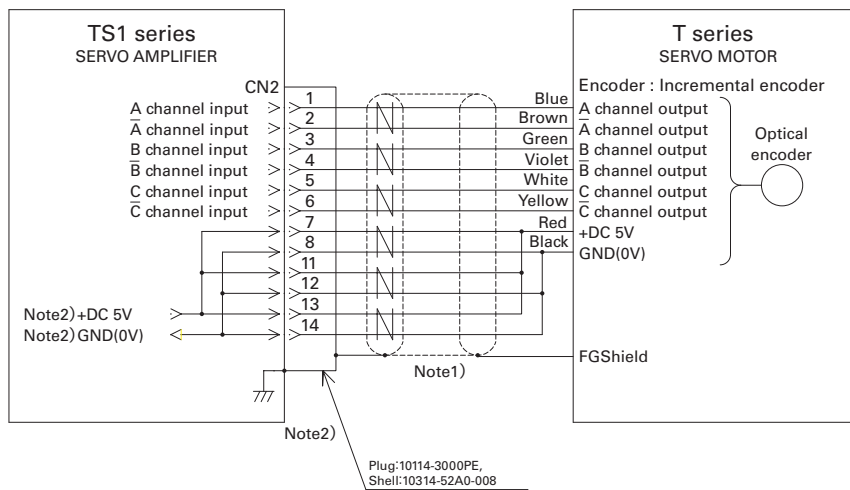

Note 1) For the parts marked , use a twisted pair shielded cable.

Note 2) The encoder power connection differs depending on the cable length. Refer to the following table.

Encoder cable length	5m or less	10m or less	20m or less
+DC 5V wiring	13-pin connection (7 and 11 pins need not be connected)	11- and 13-pin connection (7 pin need not be connected)	7-, 11- and 13-pin connection
GND (0V) wiring	14-pin connection (6 and 12 pins need not be connected)	12- and 14-pin connection (8 pin need not be connected)	8-, 12- and 14-pin connection

Tacometer generator

Tacometer generator

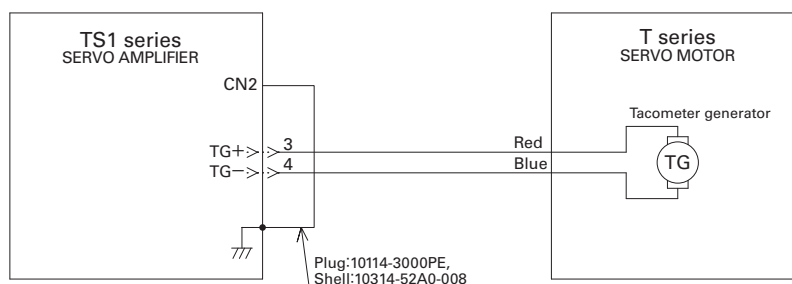

Features and Functions

Model Number Nomenclature

System Configuration

Standard Specifications

External Wiring Diagram

Dimensions

Setup Software

Optional Equipment

Servo Motor dimensions

Servo motors

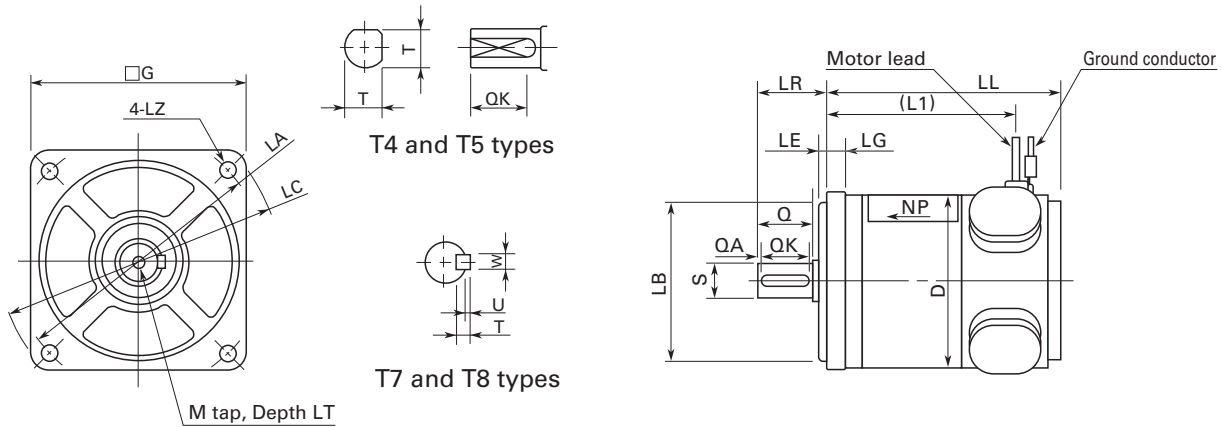

Unit : mm

Model	LL	LG	L1	LA	LB	LE	LC	G	LZ	LR	D	S	Q	QA	QK	W	T	U	M	LT
T402	55	5	42	48 ± 0.2	34-0.025 ⁰	2	56	42	3.5	24 ± 0.5	41	7-0.009 ⁰	20	—	15	w/ 2 slots,6.5			—	—
T404	69		55																	
T406	82		68																	
T506	81	5	67	60 ± 0.3	50-0.025 ⁰	2.5	69	54	4.5	24 ± 0.5	51	7-0.009 ⁰	20	—	15	w/ 2 slots,6.5			—	—
T511	101		87																	
T720	100.5	8	83	90 ± 0.3	70-0.030 ⁰	3	100	76	5.5	30 ± 0.8	76	14-0.011 ⁰	25	2	20	5	5	2	M5	8
T730	124.5		107																	
T840	134	8	113	100 ± 0.3	80-0.030 ⁰	3	112	88	6.6	35 ± 0.8	87.5	16-0.011 ⁰	30	2	25	5	5	2	M6	10
T850	149		128																	

Encoder-equipped servo motors

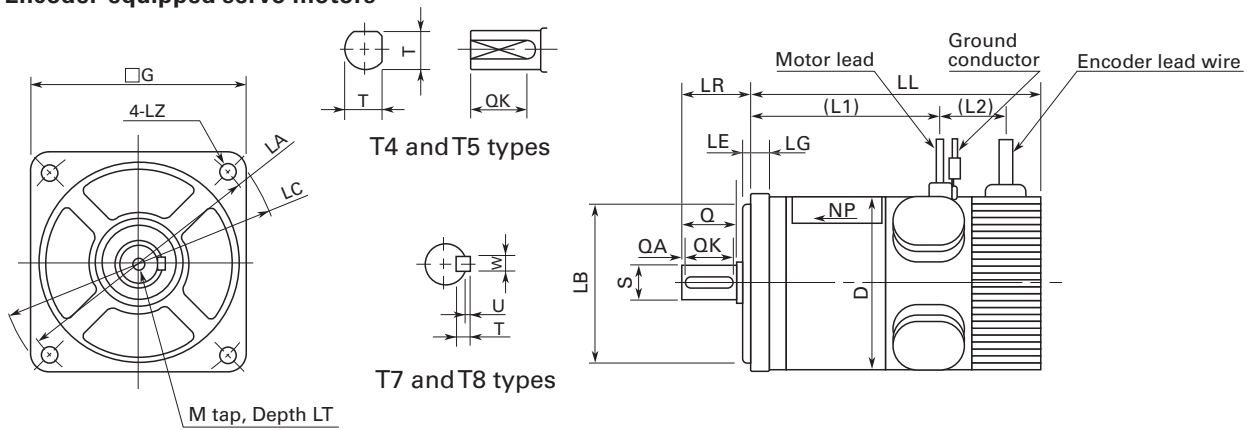

Unit : mm

Model	LL	LG	L1	L2	LA	LB	LE	LC	G	LZ	LR	D	S	Q	QA	QK	W	T	U	M	LT
T402	83	5	42	18	48 ± 0.2	34-0.025 ⁰	2	56	42	3.5	24 ± 0.5	41	7-0.009 ⁰	20	—	15	w/ 2 slots,6.5			—	—
T404	96		55																		
T406	109		68																		
T506	110.5	5	67	22	60 ± 0.3	50-0.025 ⁰	2.5	69	54	4.5	24 ± 0.5	51	7-0.009 ⁰	20	—	15	w/ 2 slots,6.5			—	—
T511	130.5		87																		
T720	134.5	8	83	36	90 ± 0.3	70-0.030 ⁰	3	100	76	5.5	30 ± 0.8	76	14-0.011 ⁰	25	2	20	5	5	2	M5	8
T730	159		107																		
T840	166	8	113	38	100 ± 0.3	80-0.030 ⁰	3	112	88	6.6	35 ± 0.8	87.5	16-0.011 ⁰	30	2	25	5	5	2	M6	10
T850	181		128																		

Tachometer generator-equipped servo motors

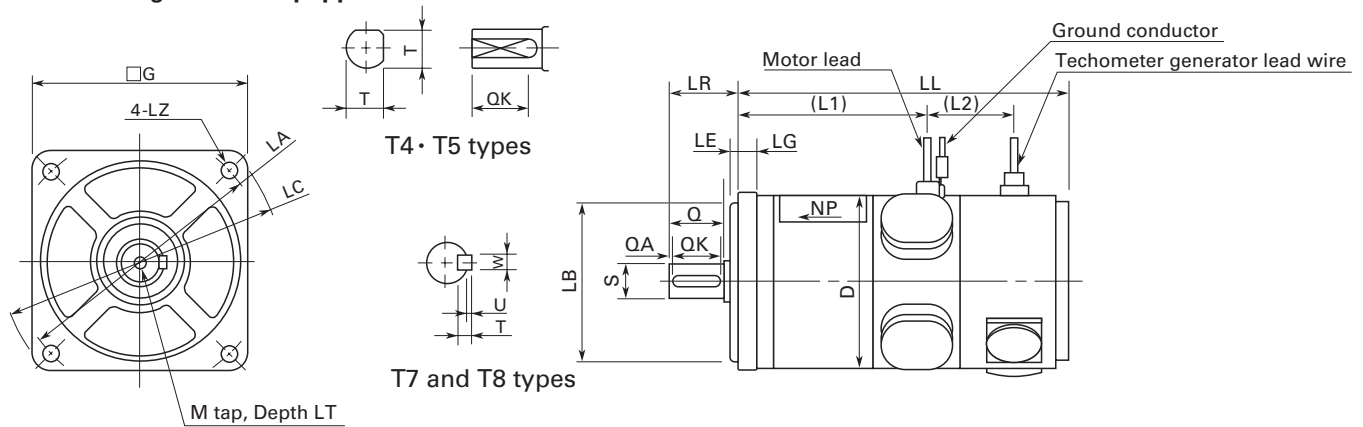

Unit : mm

Model	LL	LG	L1	L2	LA	LB	LE	LC	G	LZ	LR	D	S	Q	QA	QK	W	T	U	M	LT
T402	87.5	5	42	18	48 ± 0.2	0 34-0.025	2	56	42	3.5	24 ± 0.5	41	0 7-0.009	20	—	15	w/ 2 slots, 6.5			—	—
T404	98		55																		
T406	111		68																		
T506	124.5	5	67	22	60 ± 0.3	0 50-0.025	2.5	69	54	4.5	24 ± 0.5	51	0 7-0.009	20	—	15	w/ 2 slots, 6.5			—	—
T511	144.5		87																		
T720	148.5	8	83	36	90 ± 0.3	0 70-0.030	3	100	76	5.5	30 ± 0.8	76	0 14-0.011	25	2	20	5	5	2	M5	8
T730	172.5		107																		
T840	183	8	113	38	100 ± 0.3	0 80-0.030	3	112	88	6.6	35 ± 0.8	87.5	0 16-0.011	30	2	25	5	5	2	M6	10
T850	198		128																		

Brake-equipped servo motors

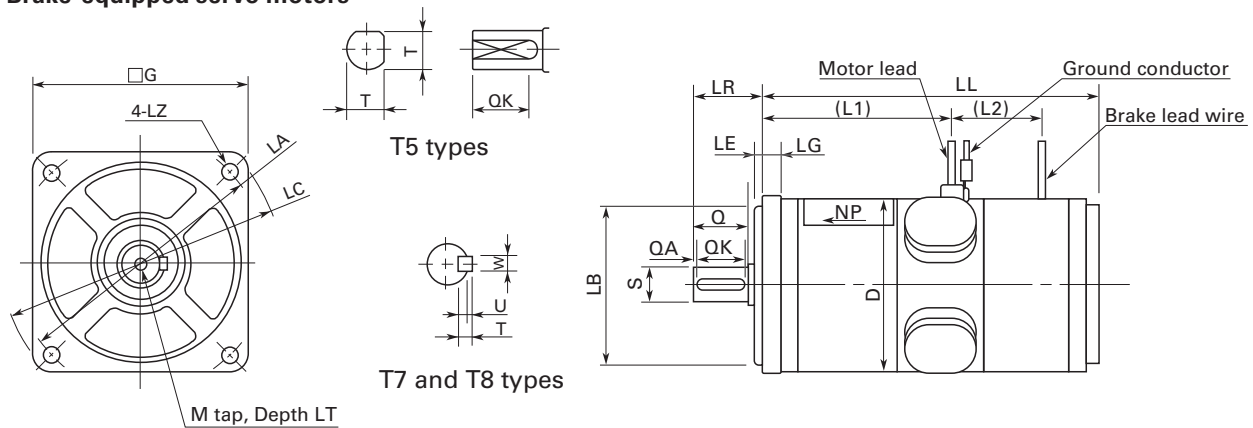

Unit : mm

Model	LL	LG	L1	L2	LA	LB	LE	LC	G	LZ	LR	D	S	Q	QA	QK	W	T	U	M	LT
T506	118	5	67	36	60 ± 0.3	0 50-0.025	2.5	69	54	4.5	24 ± 0.5	51	0 7-0.009	20	—	15	w/ 2 slots, 6.5			—	—
T511	144.5		87																		
T720	138.5	8	83	40	90 ± 0.3	0 70-0.030	3	100	76	5.5	30 ± 0.8	76	0 14-0.011	25	2	20	5	5	2	M5	8
T730	162.5		107																		
T840	169.5	8	113	40	100 ± 0.3	0 80-0.030	3	112	88	6.6	35 ± 0.8	87.5	0 16-0.011	30	2	25	5	5	2	M6	10
T850	184.5		128																		

Features and Functions

Model Number Nomenclature

System Configuration

Standard Specifications

External Wiring Diagram

Dimensions

Setup Software

Optional Equipment

Servo Motor dimensions

Encoder brake-equipped servo motors

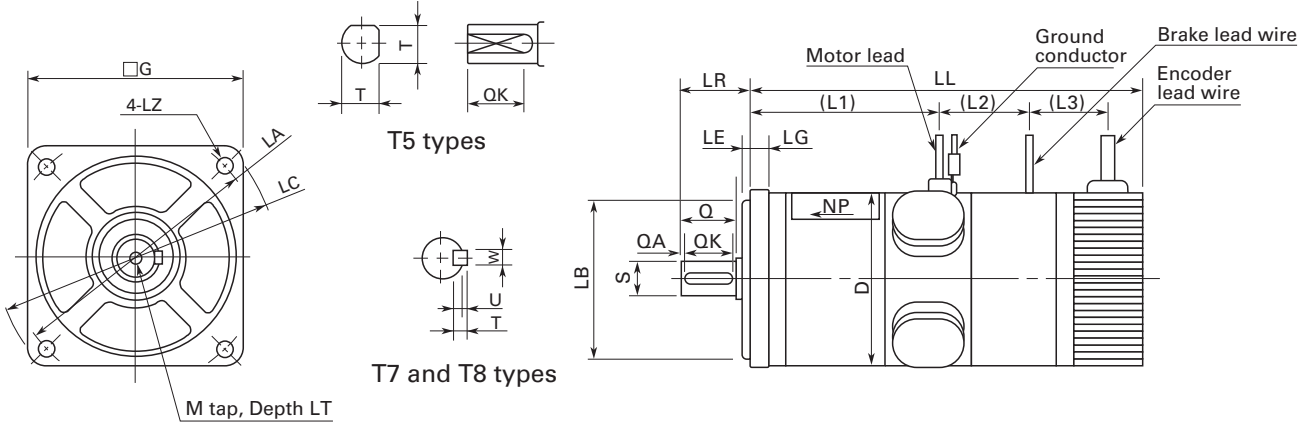

Unit : mm

Model	LL	LG	L1	L2	L3	LA	LB	LE	LC	G	LZ	LR	D	S	Q	QA	QK	W	T	U	M	LT
T506	147	5	67	36	22	60 ± 0.3	0 50-0.025	2.5	69	54	4.5	24 ± 0.5	51	0 7-0.009	20	—	15	w/ 2 slots, 6.5			—	—
T511	167		87																		—	—
T720	172.5	8	83	38	35	90 ± 0.3	0 70-0.030	3	100	76	5.5	30 ± 0.8	76	0 14-0.011	25	2	20	5	5	2	M5	8
T730	196.5		107																			
T840	203	8	113	40	35	100 ± 0.3	0 80-0.030	3	112	88	6.6	35 ± 0.8	87.5	0 16-0.011	30	2	25	5	5	2	M6	8
T850	218		128																			

Tachometer generator brake-equipped servo motors

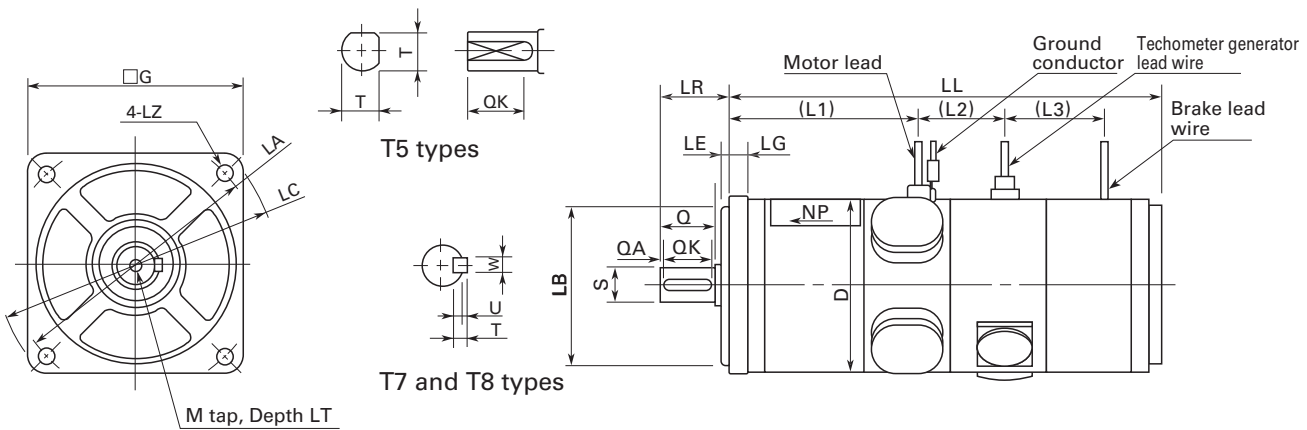

Unit : mm

Model	LL	LG	L1	L2	L3	LA	LB	LE	LC	G	LZ	LR	D	S	Q	QA	QK	W	T	U	M	LT
T506	161	5	67	38	42	60 ± 0.3	0 50-0.025	2.5	69	54	4.5	24 ± 0.5	51	0 7-0.009	20	—	15	w/ 2 slots, 6.5			—	—
T511	181		87																		—	—
T720	186.5	8	83	40	44	90 ± 0.3	0 70-0.030	3	100	76	5.5	30 ± 0.8	76	0 14-0.011	25	2	20	5	5	2	M5	8
T730	210.5		107																			
T840	219.5	8	113	38	44	100 ± 0.3	0 80-0.030	3	112	88	6.6	35 ± 0.8	87.5	0 16-0.011	30	2	25	5	5	2	M6	8
T850	234.5		128																			

Encoder tachometer generator-equipped servo motors

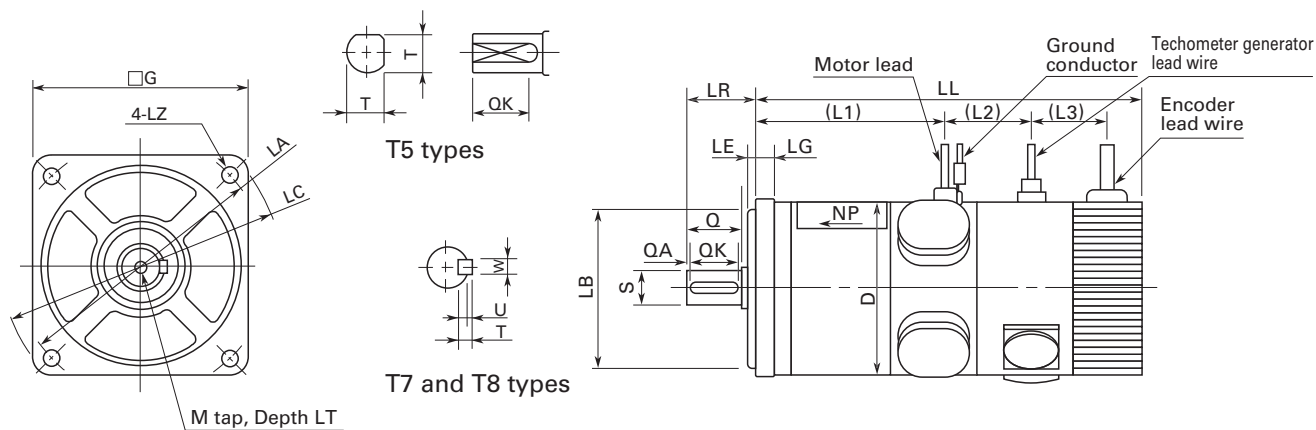

Unit : mm

Model	LL	LG	L1	L2	L3	LA	LB	LE	LC	G	LZ	LR	D	S	Q	QA	QK	W	T	U	M	LT
T506	153.5	5	67	38	27	60 ± 0.3	0 50-0.025	2.5	69	54	4.5	24 ± 0.5	51	0 7-0.009	20	—	15	w/ 2 slots, 6.5			—	—
T511	173.5		87																			
T720	182	8	83	38	40	90 ± 0.3	0 70-0.030	3	100	76	5.5	30 ± 0.8	76	0 14-0.011	25	2	20	5	5	2	M5	8
T730	206		107																			
T840	216	8	113	38	42	100 ± 0.3	0 80-0.030	3	112	88	6.6	35 ± 0.8	87.5	0 16-0.011	30	2	25	5	5	2	M6	8
T850	223.5		128																			

Encoder tachometer generator brake-equipped servo motors

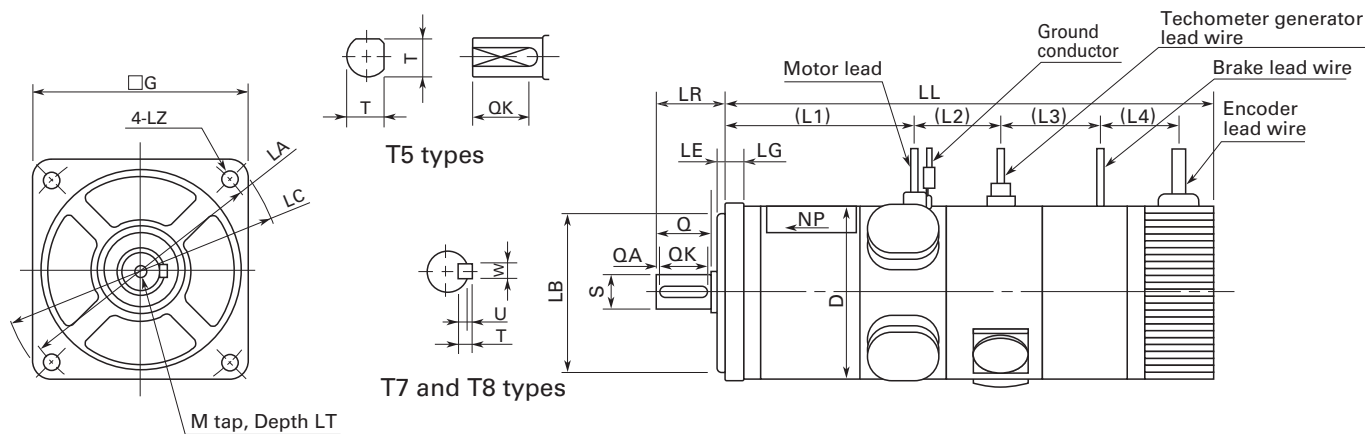

Unit : mm

Model	LL	LG	L1	L2	L3	L4	LA	LB	LE	LC	G	LZ	LR	D	S	Q	QA	QK	W	T	U	M	LT
T506	190	5	67	38	42	22	60 ± 0.3	0 50-0.025	2.5	69	54	4.5	24 ± 0.5	51	0 7-0.009	20	—	15	w/ 2 slots, 6.5			—	—
T511	210		87																				
T720	220	8	83	38	44	35	90 ± 0.3	0 70-0.030	3	100	76	5.5	30 ± 0.8	76	0 14-0.011	25	2	20	5	5	2	M5	8
T730	246		107																				
T840	253.5	8	113	38	44	35	100 ± 0.3	0 80-0.030	3	112	88	6.6	35 ± 0.8	87.5	0 16-0.011	30	2	25	5	5	2	M6	8
T850	268.5		128																				

Features and Functions

Model Number Nomenclature

System Configuration

Standard Specifications

External Wiring Diagram

Dimensions

Setup Software

Optional Equipment

Gear dimensions

Dimensions of a typical gear for T4

Unit : mm

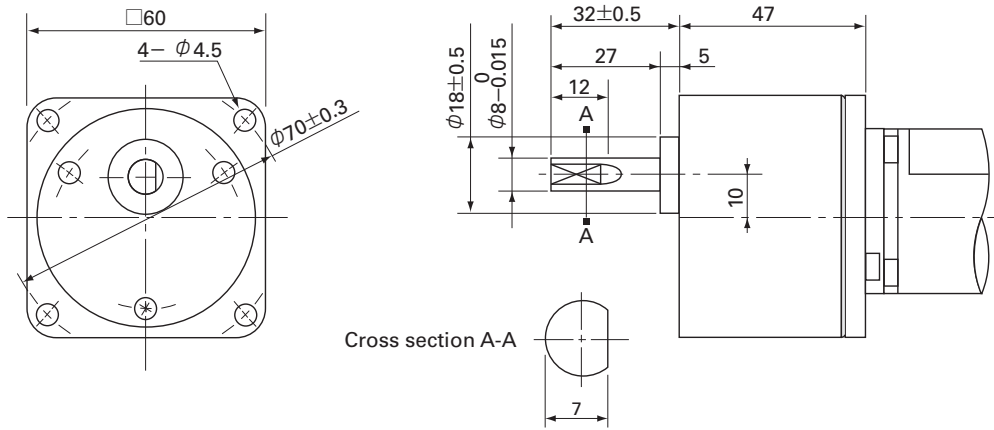

Dimensions of a typical gear for T5

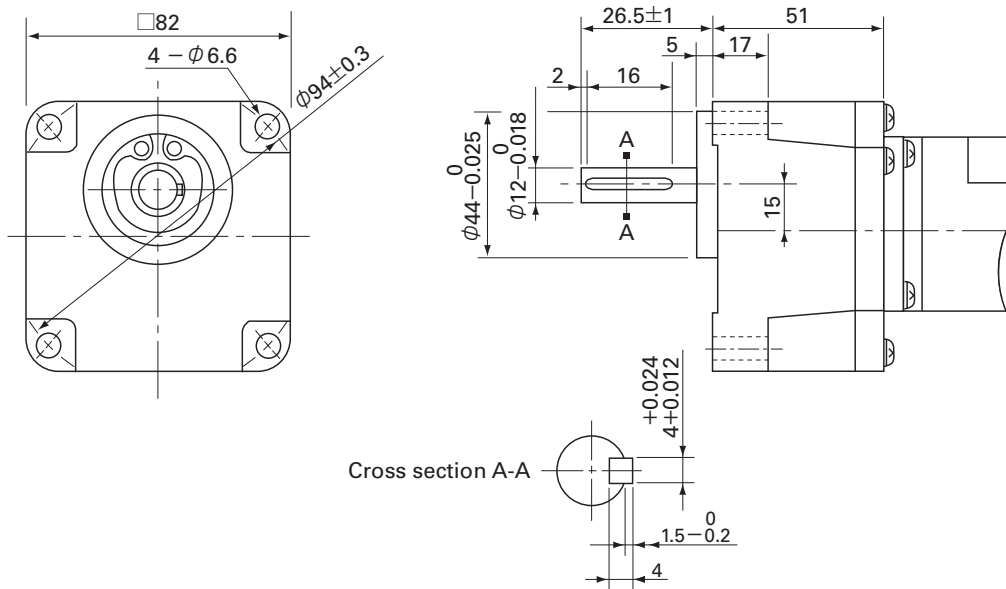

Dimensions of a typical gear for T7

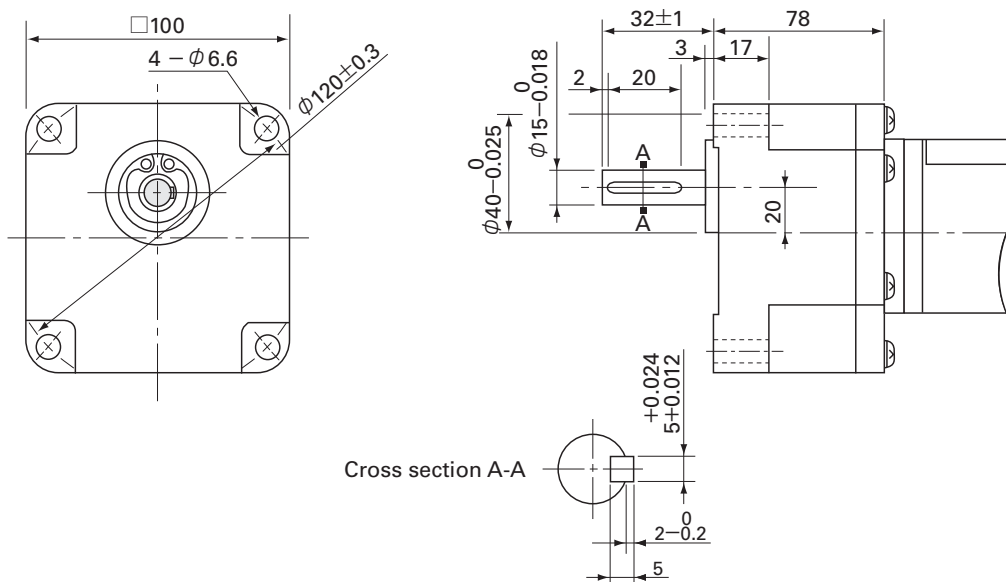

Setup Software

(1) Setup Software Start-up Screen



(2) Main Screen

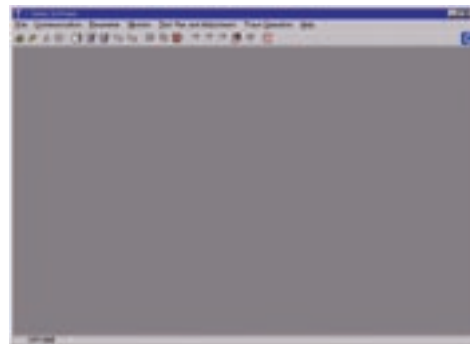

(3) Parameter Configuration Screen

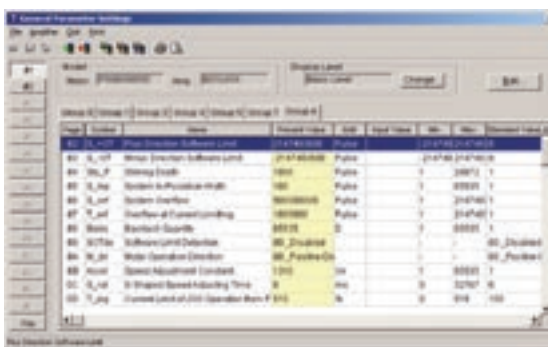

Configuration of General Parameters:
Enables parameter loading, saving, etc., via PC connection

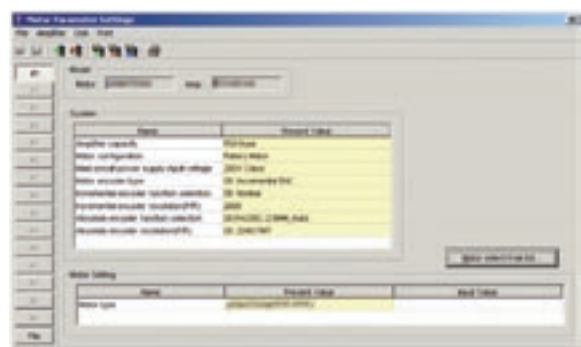

Configuration of Motor Parameters:
Combined motors can be configured via PC connection

(4) Monitor Functions

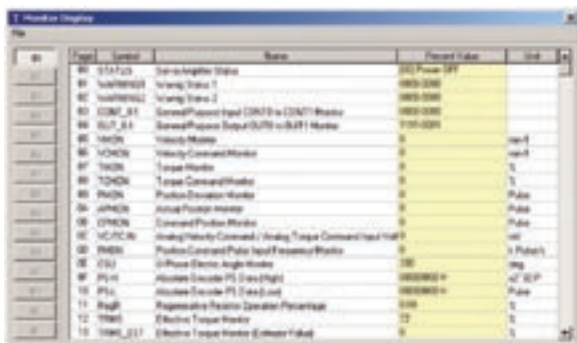

Monitor Display:
Observe Operation and Input/Output signal status

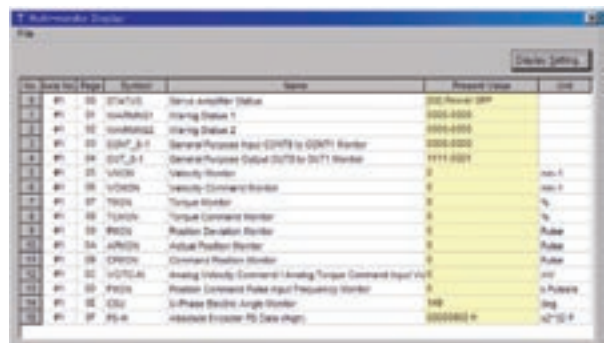

Multi-monitor Display:
Simultaneous monitoring of operational status of multiple servo amplifiers networked to a PC.

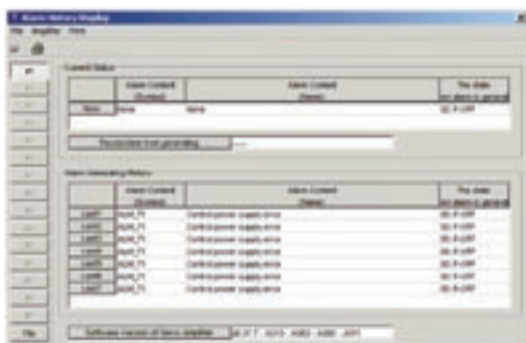

Alarm Record Display:
(Current and past alarm occurrence can be checked.)

(5) Test Run and Adjustment Function

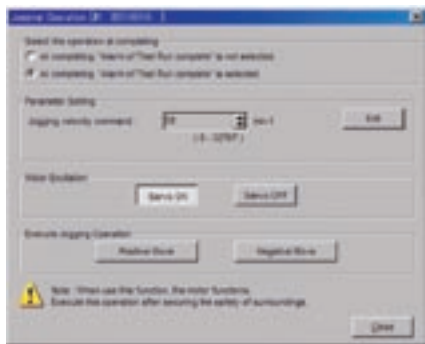

Speed Jogging:
Simplifies motor operation and the issuing of velocity commands from a PC



Pulse Feed Jogging:
Simplifies motor operation and the entering of distance and travel speed data from a PC

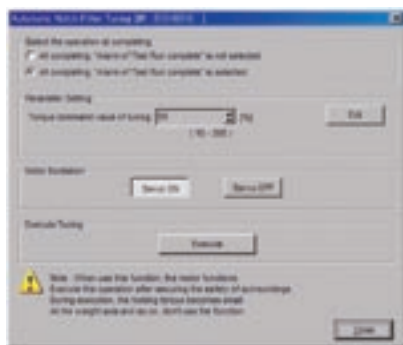

Automatic Notch Filter Tuning:
Configures the appropriate notch filter settings

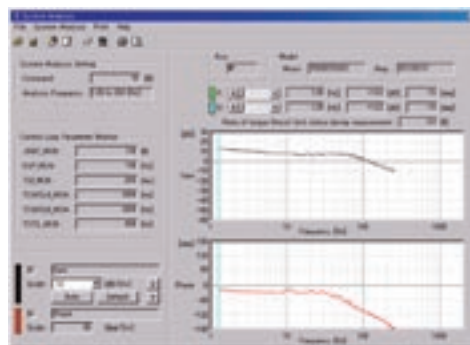

System Analysis:
Analyzes servo system frequency characteristics

(6) Trace Operation

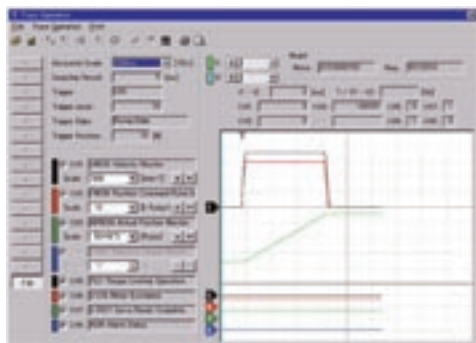

Graphically displays servo motor speed, current, and internal status

Optional Equipment

PC Interface Cable

Unit : mm

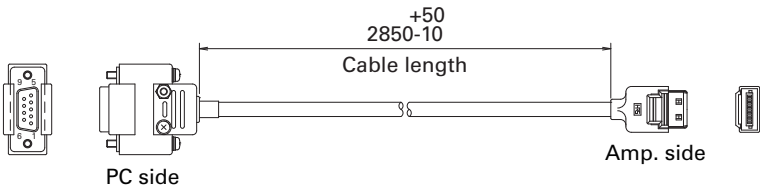

Model No.: AL-00490833-01

A note regarding RS-232C communications:
The user must provide a PC for computer interface.
Parameter settings may require adjustment.

Connector list (For Amplifier)

	Contents	Model number	Manufacturer	Manufacturer's model number
Single connector	CN1 (Plug and housing)	AL-00608709	Sumitomo 3M Ltd./Molex Ltd.	10126-3000PE + 10326-52A0-008/ 54306-2619 + 54331-0261
	CN2 (Plug and housing)	AL-00608710	Sumitomo 3M Ltd./Molex Ltd.	10114-3000PE + 10314-52A0-008/ 54306-1419 + 54331-0141
	CN3 (Housing and contact)	AL-00608711	DDK Ltd./ Tyco Electronics AMP K.K.	DK-3100S-05R + DK-3RECLLP1-100/ 1-178288-5 + 1-175218-2
	CN4 (Housing and contact)	AL-00608712	DDK Ltd./ Tyco Electronics AMP K.K.	DK-3100S-03R + DK-3RECLLP1-100/ 1-178288-3 + 1-175218-2
Standard set	CN1,2 (Plug and housing)	AL-00608713	Sumitomo 3M Ltd./Molex Ltd.	10126-3000PE + 10326-52A0-008/ 10114-3000PE + 10314-52A0-008/ 54306-2619 + 54331-0261 54306-1419 + 54331-0141
	CN3,4 (Housing and contact)		DDK Ltd./ Tyco Electronics AMP K.K.	DK-3100S-05R + DK-3RECLLP1-100/ DK-3100S-03R + DK-3RECLLP1-100/ 1-178288-5 + 1-175218-2 1-178288-3 + 1-175218-2

Note1) CN1,2 ... Sumitomo 3M company product and Molex company product are standardized goods.

Note2) CN3,4 ... DDK company product and Tyco electronics AMP company product are standardized goods.

* Hand crimp tool for contacts can be used for both.

Connector list (For Power Unit)

	Contents	Model number	Manufacturer	Manufacturer's model number
Single connector	CN1 (Housing and contact)	AL-00632983	DDK Ltd./ Tyco Electronics AMP K.K.	DK-3100D-06R + DK-3RECLLP1-100/ 178289-3 + 1-175218-2
	CN2 (Housing and contact)	AL-00632984	DDK Ltd./ Tyco Electronics AMP K.K.	DK-3100D-12R + DK-3RECLLP1-100/ 178289-6 + 1-175218-2
	CN3 (Housing and contact)	AL-00632985	J.S.T Mfg Co Ltd.	VHR-2N + SVH-21T-P1.1
Standard set	CN1,2 (Housing and contact)	AL-00632986	DDK Ltd./ Tyco Electronics AMP K.K.	DK-3100D-06R + DK-3RECLLP1-100/ DK-3100D-12R + DK-3RECLLP1-100/ 178289-3 + 1-175218-2 178289-6 + 1-175218-2
	CN3 (Housing and contact)		J.S.T Mfg Co Ltd.	VHR-2N + SVH-21T-P1.1

Note1) CN1,2 ... DDK company product and Tyco electronics AMP company product are standardized goods.

* Hand crimp tool for contacts can be used for both.

Note2) Standard set(AL-00632986) is attached to the Power Unit.

Brush (Maintenance components)

Applicable motor	Model number
For T4 model motor	S441898-1A-02
For T5 model motor	S441899-1A-02
For T7 model motor	S442425-1A-02
For T8 model motor	S442427-1A-02
For T4 model tachometer generator-equipped motor	S813053-1A-87
For T5 model tachometer generator-equipped motor	S782281-1A-87
For T7 and T8 model tachometer generator-equipped motor	S782279-1A-87

Regenerative Resistor

Regenerative power [PM]	Model number	Resistance	Allowable power [PRO]	Thermostat
10W Max.	REGIST-080W50B	50 Ω	10W	b contact
30W Max.	REGIST-120W50B	50 Ω	30W	
Less than 55W	REGIST-220W50B	50 Ω	55W	
	REGIST-220W20B	20 Ω		
55W Min.	Please contact us			

External Regenerative Resistor Dimensions

(Unit: mm)

REGIST-080W50B

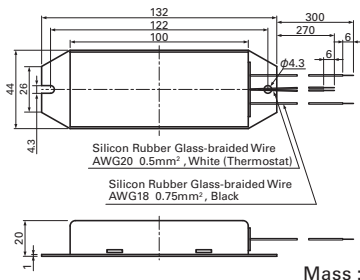

REGIST-120W50B

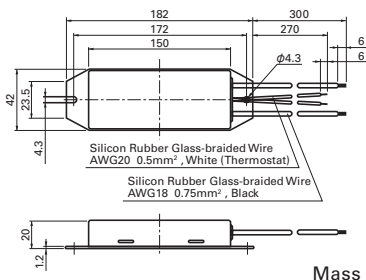

REGIST-220W20B, REGIST-220W50B

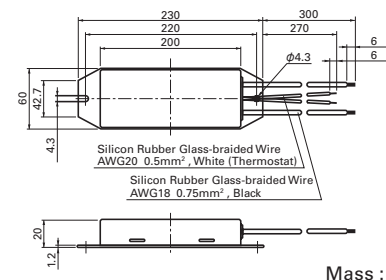

Blank area with horizontal dashed lines for notes.

Features and Functions

Model Number Nomenclature

System Configuration

Standard Specifications

External Wiring Diagram

Dimensions

Setup Software

Optional Equipment

Inquiry Check Sheet

Please provide the following information when placing an order or making an inquiry.
Also feel free to include any questions that require our attention.

Company Name : _____

Date : _____

Department : _____

To contact us : _____

Telephone : _____

Phone : +81 3 3917 4141

Fax : _____

FAX : +81 3 5394 3427

1) Application : _____

2) Name of Machinery : _____

3) Number of Units : _____

Item	Contents																																																																																																
①	Name of target equipment Equipment name, category (transport, processing, test, other)																																																																																																
②	Name of servo axis Axis name, axial mechanism (horizontal/vertical), brake mechanism (yes/no)																																																																																																
③	Current condition of above axis Manufacturer Name () Series Name () Motor Capacity () Hydraulic, Mechanical, or New System ()																																																																																																
④	Positioning accuracy \pm mm \pm μ m																																																																																																
⑤	Operation pattern <div style="display: flex; align-items: center;"> <div style="flex: 1;"> <p style="font-size: small;">Acceleration α: ___ G ___ [m/s²] Feeding Speed V: ___ [m/s] Moving Distance D: ___ [m] Time [sec]</p> </div> <div style="flex: 1; padding-left: 10px;"> <p>[Reference formula] $1G=9.8[m/s^2]$, $1[m/s^2]=0.1G$ $\alpha[m/s^2]=V[m/sec] \div t1[sec]$ $D[m]=V[m/sec] \times (t1+t2)[sec]$</p> </div> </div>																																																																																																
⑥	Mechanism Ball-screw/screw-rotation type (horizontal), ball-screw/nut-rotation type (horizontal), rack and pinion (horizontal), belt/chain (horizontal), rotary table, roll feed, instability																																																																																																
⑦	Mechanical structure <table style="width: 100%; font-size: x-small;"> <tr> <td>WT (table mass)</td><td>kg</td><td>WL (work mass)</td><td>kg</td><td>WA (mass of other drive parts)</td><td>kg</td> </tr> <tr> <td>WR (rack mass)</td><td>kg</td><td>WB (belt/chain mass)</td><td>kg</td><td>WC (counterbalance mass)</td><td>kg</td> </tr> <tr> <td>Fa (external force axial direction)</td><td>N</td><td>Fb (ball-screw preload)</td><td>N</td><td>T (roll pushing force)</td><td>N</td> </tr> <tr> <td>Dr1 (drive-side roll diameter)</td><td>mm</td><td>Dr2 (follower-side roll diameter)</td><td>mm</td><td></td><td></td> </tr> <tr> <td>Lr1 (drive-side roll length)</td><td>mm</td><td>Lr2 (follower-side roll length)</td><td>mm</td><td>G (reduction ratio)</td><td></td> </tr> <tr> <td>JG (speed-reducer inertia)</td><td>kg·m²</td><td>JC (coupling inertia)</td><td>kg·m²</td><td></td><td></td> </tr> <tr> <td>JN (nut inertia)</td><td>kg·m²</td><td>JO (other motor-axis conversion inertia)</td><td>kg·m²</td><td></td><td></td> </tr> <tr> <td>Db (ball-screw diameter)</td><td>mm</td><td>Lb (ball-screw axial length)</td><td>mm</td><td>Pb (ball-screw lead)</td><td>mm</td> </tr> <tr> <td>Dp (pinion/pulley diameter)</td><td>mm</td><td>Lp (pinion axial length)</td><td>mm</td><td>tp (pulley thickness)</td><td>mm</td> </tr> <tr> <td>Dt (table diameter)</td><td>mm</td><td>Dh (table-support diameter)</td><td>mm</td><td>LW (load shift from axis)</td><td>mm</td> </tr> <tr> <td>Ds (table shaft diameter)</td><td>mm</td><td>Ls (table shaft length)</td><td>mm</td><td></td><td></td> </tr> <tr> <td>ρ (specific gravity of ball-screw/pinion/pulley/table-shaft material)</td><td></td><td>$\rho 1$ (specific gravity of roll-1 material)</td><td>kg/cm³</td><td></td><td></td> </tr> <tr> <td>μ (friction coefficient between sheet and sliding-surface/support-section/roll)</td><td></td><td>κ (internal friction coefficient of preload nut)</td><td></td><td></td><td></td> </tr> <tr> <td>$\rho 2$ (specific gravity of roll-2 material)</td><td>kg/cm³</td><td>JL (load inertia of motor-axis conversion)</td><td>kg·m²</td><td></td><td></td> </tr> <tr> <td>η (mechanical efficiency)</td><td></td><td>Tu (imbalance torque of motor axis conversion)</td><td>N·m</td><td></td><td></td> </tr> <tr> <td>TF (friction torque of motor axis conversion)</td><td>N·m</td><td></td><td></td><td></td><td></td> </tr> </table>	WT (table mass)	kg	WL (work mass)	kg	WA (mass of other drive parts)	kg	WR (rack mass)	kg	WB (belt/chain mass)	kg	WC (counterbalance mass)	kg	Fa (external force axial direction)	N	Fb (ball-screw preload)	N	T (roll pushing force)	N	Dr1 (drive-side roll diameter)	mm	Dr2 (follower-side roll diameter)	mm			Lr1 (drive-side roll length)	mm	Lr2 (follower-side roll length)	mm	G (reduction ratio)		JG (speed-reducer inertia)	kg·m ²	JC (coupling inertia)	kg·m ²			JN (nut inertia)	kg·m ²	JO (other motor-axis conversion inertia)	kg·m ²			Db (ball-screw diameter)	mm	Lb (ball-screw axial length)	mm	Pb (ball-screw lead)	mm	Dp (pinion/pulley diameter)	mm	Lp (pinion axial length)	mm	tp (pulley thickness)	mm	Dt (table diameter)	mm	Dh (table-support diameter)	mm	LW (load shift from axis)	mm	Ds (table shaft diameter)	mm	Ls (table shaft length)	mm			ρ (specific gravity of ball-screw/pinion/pulley/table-shaft material)		$\rho 1$ (specific gravity of roll-1 material)	kg/cm ³			μ (friction coefficient between sheet and sliding-surface/support-section/roll)		κ (internal friction coefficient of preload nut)				$\rho 2$ (specific gravity of roll-2 material)	kg/cm ³	JL (load inertia of motor-axis conversion)	kg·m ²			η (mechanical efficiency)		Tu (imbalance torque of motor axis conversion)	N·m			TF (friction torque of motor axis conversion)	N·m				
WT (table mass)	kg	WL (work mass)	kg	WA (mass of other drive parts)	kg																																																																																												
WR (rack mass)	kg	WB (belt/chain mass)	kg	WC (counterbalance mass)	kg																																																																																												
Fa (external force axial direction)	N	Fb (ball-screw preload)	N	T (roll pushing force)	N																																																																																												
Dr1 (drive-side roll diameter)	mm	Dr2 (follower-side roll diameter)	mm																																																																																														
Lr1 (drive-side roll length)	mm	Lr2 (follower-side roll length)	mm	G (reduction ratio)																																																																																													
JG (speed-reducer inertia)	kg·m ²	JC (coupling inertia)	kg·m ²																																																																																														
JN (nut inertia)	kg·m ²	JO (other motor-axis conversion inertia)	kg·m ²																																																																																														
Db (ball-screw diameter)	mm	Lb (ball-screw axial length)	mm	Pb (ball-screw lead)	mm																																																																																												
Dp (pinion/pulley diameter)	mm	Lp (pinion axial length)	mm	tp (pulley thickness)	mm																																																																																												
Dt (table diameter)	mm	Dh (table-support diameter)	mm	LW (load shift from axis)	mm																																																																																												
Ds (table shaft diameter)	mm	Ls (table shaft length)	mm																																																																																														
ρ (specific gravity of ball-screw/pinion/pulley/table-shaft material)		$\rho 1$ (specific gravity of roll-1 material)	kg/cm ³																																																																																														
μ (friction coefficient between sheet and sliding-surface/support-section/roll)		κ (internal friction coefficient of preload nut)																																																																																															
$\rho 2$ (specific gravity of roll-2 material)	kg/cm ³	JL (load inertia of motor-axis conversion)	kg·m ²																																																																																														
η (mechanical efficiency)		Tu (imbalance torque of motor axis conversion)	N·m																																																																																														
TF (friction torque of motor axis conversion)	N·m																																																																																																
⑧	Speed reducer Customer-provided (/) Sanyo denki standard (planet/spur/no-backlash-planet /) other (/)																																																																																																
⑨	Types of detector Encoder type specified (yes / no) Yes: (incremental encoder, absolute encoder) Resolution () Tachometer generator																																																																																																
⑩	Input format Position, velocity, torque, other ()																																																																																																
⑪	Host equipment (controller) Sequencer, laptop, customer-developed product, Sanyo denki-provided, other ()																																																																																																
⑫	Usage environment and other requirements Cutting, clean-room use, anti-dust measures, other ()																																																																																																
⑬	Estimated production Single product: () units/month () units/year																																																																																																
⑭	Development schedule Prototype period: () Year () Month Production period: () Year () Month																																																																																																
⑮	Various measures Related documentation (already submitted; send later by mail) Visit/PR desired (yes / no) Meeting desired (yes / no)																																																																																																
⑯	Miscellaneous (questions, pending problems, unresolved issues, etc.)																																																																																																

■ Precautions For Adoption

Failure to follow the precautions on the right may cause moderate injury and property damage, or in some circumstances, could lead to a serious accident. Always follow all listed precautions.

Cautions

- Read the accompanying Instruction Manual carefully prior to using the product.
- If applying to medical devices and other equipment affecting people's lives, please contact us beforehand and take appropriate safety measures.
- If applying to equipment that can have significant effects on society and the general public, please contact us beforehand.
- Do not use this product in an environment where vibration is present, such as in a moving vehicle or shipping vessel.
- Do not perform any retrofitting, re-engineering, or modification to this equipment.
- The products presented in this catalog are meant to be used for general industrial applications.
If using for special applications related to aviation and space, nuclear power, electric power, submarine repeaters, etc., please contact us beforehand.

*For any question or inquiry regarding the above, contact our Sales Department.

<http://www.sanyodenki.com>

SANYO DENKI CO., LTD.

1-15-1, Kita-Otsuka, Toshima-ku, Tokyo 170-8451, Japan

Phone: +81 3 3917 5157

SANYO DENKI AMERICA, INC.

468 Amapola Avenue Torrance, CA 90501 U.S.A.

Phone: +1 310 783 5400

SANYO DENKI EUROPE SA.

P.A. Paris Nord II 48 Allee des Erables-VILLEPINTE BP:57286 F-95958 ROISSY CDG Cedex France

Phone: +33 1 48 63 26 61

SANYO DENKI GERMANY GmbH

Frankfurter Strasse 92, 65760 Eschborn Germany

Phone: +49 6196 76113 0

SANYO DENKI KOREA CO., LTD.

9F 5-2, Sunwha-dong Jung-gu Seoul, 100-130, Korea

Phone: +82 2 773 5623

SANYO DENKI SHANGHAI CO., LTD.

Rm2107-2109, Bldg A, Far East International Plaza, No.319, Xianxia Rd., Shanghai, 200051, China

Phone: +86 21 6235 1107

SANYO DENKI TAIWAN CO., LTD.

Room 1208, 12F, No.96 Chung Shan N, Rd., Sec.2, Taipei 104, Taiwan, R.O.C.

Phone: +886 2 2511 3938

SANYO DENKI (H.K.) CO., LIMITED

Room 2305, 23/F, South Tower, Concordia Plaza, 1 Science Museum Rd., TST East, Kowloon, Hong Kong

Phone: +852 2312 6250

SANYO DENKI SINGAPORE PTE. LTD.

10 Hoe Chiang Road #14-03A/04 Keppel Towers Singapore 089315

Phone: +65 6223 1071

The names of companies and/or their products specified in this catalogue are the trade names, and/or trademarks and/or registered trademarks of such respective companies.

*Remarks : Specifications Are Subject To Change Without Notice.

CATALOG NO. S0767B008 '12.12.A